

Prepared by: **Matthew L. Winton, Esq.**
Vaughn & Winton pllc
2801 East Memorial Road, Suite 110
Edmond, Oklahoma 73013
405.478.4818/405.478.4819 fax
www.vaughnandwinton.com

Doc#:R 2005 53784
Bk&Pg:RB 4095 1149-1273
Filed:11-16-2005 LDM
10:57:48 AM RT
Cleveland County, OK

DECLARATION OF COVENANTS, CONDITIONS, AND RESTRICTIONS FOR TRAILWOODS, A RESIDENTIAL COMMUNITY TO THE CITY OF NORMAN, CLEVELAND COUNTY, STATE OF OKLAHOMA.

TABLE OF CONTENTS

Section 1 Creation of the Community

- 1.1 Purpose and Intent
- 1.2 Binding Effect and Term
- 1.3 Governing Documents

Section 2 Definitions

- 2.1 Association
- 2.2 Base Assessment
- 2.3 Board of Directors or Board
- 2.4 Builder
- 2.5 Class "B" Control Period
- 2.6 Common Area
- 2.7 Common Expenses
- 2.8 Condominium
- 2.9 Declarant
- 2.10 Development Plan
- 2.11 Member
- 2.12 Mortgage
- 2.13 Owner
- 2.14 Person
- 2.15 Record, Recording, or Recorded
- 2.16 Special Assessment
- 2.17 Specific Assessment
- 2.18 Supplemental Declaration
- 2.19 Trailwoods
- 2.20 Trailwoods Governing Documents
- 2.21 Trailwoods-Wide Standard
- 2.22 Unit
- 2.23 Use Restrictions and Rules

Section 3 Use and Conduct

- 3.1 Framework for Regulation
- 3.2 Rule Making Authority

- 3.3 Owners' Acknowledgment and Notice to Purchasers
- 3.4 Protection of Owners and Others

Section 4 Architecture and Landscaping

- 4.1 General
- 4.2 New Construction
- 4.3 Modifications
- 4.4 No Waiver of Future Approvals
- 4.5 Variances
- 4.6 Limitation of Liability
- 4.7 Certificate of Compliance
- 4.8 Fees; Assessments
- 4.9 Declarant, Design Review Board, and ARC Addresses

Section 5 Maintenance and Repair

- 5.1 Maintenance of Units
- 5.2 Responsibility for Repair and Replacement

Section 6 The Association and its Members

- 6.1 Function of Association
- 6.2 Membership
- 6.3 Voting

Section 7 Association Powers and Responsibilities

- 7.1 Acceptance and Control of Association Property
- 7.2 Maintenance of Common Areas
- 7.3 Insurance
- 7.4 Compliance and Enforcement
- 7.5 Implied Rights; Board Authority
- 7.6 Indemnification of Officers, Directors and Others
- 7.7 Security
- 7.8 Provision of Services
- 7.9 Facilities and Services Open to the Public
- 7.10 Association's Responsibility with Respect to Transfer of Units

Section 8 Association Finances

- 8.1 Budgeting and Allocating Common Expenses
- 8.2 Budgeting for Reserves
- 8.3 Special Assessments
- 8.4 Specific Assessments
- 8.5 Authority to Assess Owners; Time of Payment
- 8.6 Obligation for Assessments
- 8.7 Lien for Assessments
- 8.8 Exempt Property
- 8.9 Limitation on Increases of Assessments

Section 9 Expansion of Trailwoods

- 9.1 Expansion by Declarant
- 9.2 Expansion by the Association
- 9.3 Additional Covenants and Easements
- 9.4 Effect of Recording Supplemental Declaration
- 9.5 Condominium Conversions

Section 10 Additional Rights Reserved to Declarant

- 10.1 Withdrawal of Property
- 10.2 Marketing and Sales Activities
- 10.3 Right To Develop
- 10.4 Right To Approve Changes in Standards
- 10.5 Right To Transfer or Assign Declarant Rights
- 10.6 Exclusive Rights To Use Name of Development
- 10.7 Termination of Rights

Section 11 Easements

- 11.1 Easements in Common Area
- 11.2 Easements of Encroachment
- 11.3 Easements for Utilities, Etc.
- 11.4 Easements To Serve Additional Property
- 11.5 Easements for Maintenance, Emergency and Enforcement
- 11.6 Easements for Irrigation, Detention/Retention Maintenance and Flood Water
- 11.7 Easements for Drainage Areas
- 11.8 Easement for Screening and Fencing

Section 12 Dispute Resolution and Limitation on Litigation

- 12.1 Consensus for Association Litigation
- 12.2 Dispute Resolution and Enforcement

Section 13 Mortgagee Provisions

- 13.1 Notices of Action
- 13.2 Special FHLMC Provision
- 13.3 Other Provisions for First Lien Holders
- 13.4 Amendments to Documents
- 13.5 No Priority
- 13.6 Notice to Association
- 13.7 Failure of Mortgagee To Respond
- 13.8 Construction of Section 13

Section 14 Relationship with City of Norman, Cleveland County, and Media

Section 15 Changes in Ownership of Units

Section 16 Changes in Common Areas

- 16.1 Condemnation
- 16.2 Partition
- 16.3 Transfer or Dedication of Common Area

Section 17 Amendment of Declaration

- 17.1 By Declarant
- 17.2 By Members
- 17.3 Validity and Effective Date
- 17.4 Exhibits

TABLE OF EXHIBITS

- Exhibit "A" – The Property
- Exhibit "B" – The Lands Subject to Annexation or Addition
- Exhibit "C" – Initial Use Restrictions and Rules
- Exhibit "D" – By-Laws of Trailwoods Property Owners Association, Inc.
- Exhibit "E" – Calculation of Assessments
- Exhibit "F" – Initial Design Review Guidelines

**DECLARATION OF COVENANTS, CONDITIONS, AND
RESTRICTIONS FOR TRAILWOODS, A RESIDENTIAL COMMUNITY
TO THE CITY OF NORMAN, CLEVELAND COUNTY, OKLAHOMA.**

THIS DECLARATION OF COVENANTS, CONDITIONS, AND RESTRICTIONS is made this _____ day of _____, 2005, by Terra Verde, L.L.C., an Oklahoma limited liability company ("Declarant").

PART ONE: INTRODUCTION TO THE COMMUNITY

The Declarant has established this Declaration to provide a governance structure and a flexible system of standards and procedures for the overall development, administration, maintenance, and preservation of Trailwoods as a quality residential community. Trailwoods Property Owners Association (the Association, or Trailwoods Association) is a homeowners association comprised of all owners of real property in Trailwoods.

The Trailwoods Association has the power under the Governing Documents to establish standards for conduct and activities for the property within Trailwoods. Another component of the Trailwoods development is the Design Review Board, which has jurisdiction over all matters of design review for all property within Trailwoods.

Section 1 Creation of the Community.

1.1 Purpose and Intent.

Declarant, as the owner of the real property described in Exhibit "A," intends by the Recording of this Declaration to create a general plan of development for the planned community known as Trailwoods. This Declaration provides a flexible and reasonable procedure for future expansion of Trailwoods to include additional real property as Declarant deems appropriate and provides for the overall development, administration, maintenance and preservation of the real property now and hereafter comprising Trailwoods. An integral part of the development plan is the creation of Trailwoods Association, an association comprised of all owners of real property in Trailwoods, to own, operate and/or maintain various common areas and community improvements and to administer and enforce this Declaration and the other Governing Documents referred to in this Declaration.

This Declaration does not and is not intended to create a unit ownership estate within the meaning of *60 O.S. §501 et seq.* This document does and is intended to create a real estate development and owners association within the meaning of *60 O.S. §851 et seq.*

1.2 Binding Effect and Term.

All property described in Exhibit "A" and any additional property which is made a part of Trailwoods in the future by Recording one or more Supplemental Declarations, shall be owned, conveyed and used subject to all of the provisions of this Declaration, which shall run with the land and title to such property. This Declaration shall be binding upon all Persons having any

right, title, or interest in any portion of Trailwoods, their heirs, successors, successors-in-title, and assigns.

This Declaration shall remain in effect for a term of 40 years from the date it is Recorded. Declarant, the Association, any Owner and their respective legal representatives, heirs, successors, and assigns may enforce it. After such 40-year period, the Declaration's term shall automatically extend for successive 10-year periods unless 75% of the then Owners sign and Record, within the year preceding any extension, an instrument which terminates, add to, or amends, in whole, or in part, this Declaration.

If any provision of this Declaration would be unlawful, void, or voidable by reason of applicability of the rule against perpetuities, such provision shall expire 21 years after the death of the last survivor of the now living descendants of the youngest living President of the United States having a descendant. Nothing in this Section shall be construed to permit termination of any easement, covenant, restriction, or obligation created in this Declaration without the consent of the holder of such easement.

1.3 Governing Documents.

Trailwoods Governing Documents create a general plan of development for Trailwoods which may be supplemented by additional covenants, restrictions, and easements applicable to the property within Trailwoods. In the event of a conflict between or among Trailwoods Governing Documents and any such additional covenants or restrictions, and/or the provisions of any other articles of incorporation, By-Laws, or rules or policies, the Declaration shall control.

Nothing in this Section shall preclude the Recording of a Supplemental Declaration or other instrument applicable to any portion of Trailwoods containing additional restrictions or more restrictive provisions. However, any Person who seeks to Record any instrument applicable to Trailwoods must obtain Declarant's written consent so long as Declarant owns any property described in Exhibits "A" or "B" of this Declaration (collectively, the Properties). Any attempted Recordation without such consent shall result in such instrument being void and of no force and effect unless subsequently approved by Recorded consent signed by Declarant, so long as Declarant owns any property described in Exhibit "A" or Exhibit "B."

All provisions of Trailwoods Governing Documents shall apply to all Owners and to all occupants of all Units, as well as their respective tenants, guests and invitees. Any lease of a Unit shall provide that the lessee and all occupants of the leased Unit shall be bound by the terms of Trailwoods Governing Documents.

If any provision of this Declaration is determined by judgment or court order to be invalid, or invalid as applied in a particular instance, such determination shall not affect the validity of other provisions or applications.

Section 2 Definitions.

The terms used in Trailwoods Governing Documents shall be given their natural,

commonly accepted definitions unless otherwise specified. Capitalized terms shall be defined as set forth below. If not defined herein, capitalized terms shall be defined as set forth in the Declaration, as applicable.

2.1 "**Association**": Trailwoods Property Owners Association, an Oklahoma nonprofit corporation, its successors or assigns.

2.2 "**Base Assessment**": Assessments levied on all Units subject to assessment under Section 8 to fund Common Expenses for the general benefit of all Units, as determined in accordance with Section 8.1.

2.3 "**Board of Directors**" or "**Board**": The body responsible for administration of the Association, selected as provided in the By-Laws. Unless otherwise specifically noted, any reference to the Board in this Declaration means Trailwoods Association Board.

2.4 "**Builder**": Any Person who purchases one or more Units for the purpose of constructing improvements for later sale to consumers, or who purchases one or more parcels of land within Trailwoods for further subdivision, development, or resale in the ordinary course of such Person's business.

2.5 "**Class "B" Control Period**": The period of time during which the Class "B" Member is entitled to exercise any addition or annexation rights under Section 9.1 to this Declaration.

2.6 "**Common Area**": All real and personal property, including easements, which the Association owns, leases or otherwise holds possessory or use rights in for the common use and enjoyment of the Owners.

2.7 "**Common Expenses**": The actual and estimated expenses incurred, or anticipated to be incurred, by the Association for the general benefit of all Owners, including any reasonable reserve, as the Board may find necessary and appropriate pursuant to Trailwoods Governing Documents. Common Expenses shall not be limited to those expenses relative to the care of Common Area.

2.8 "**Condominium**": The form of ownership as defined under the Oklahoma Unit Ownership Estate Act, 60 O.S. §501 et seq.

2.9 "**Declarant**": Terra Verde, L.L.C., an Oklahoma limited liability company, or any successor or assign who takes title to any portion of the property described in Exhibits "A" or "B" for the purpose of development and/or sale and who is designated as Declarant in a Recorded instrument executed by the immediately preceding Declarant.

2.10 "**Development Plan**": The land use plan for the development of Trailwoods approved by Cleveland County, as it may be required and amended, which may include all of the property described in Exhibit "A" and all or a portion of the property described in Exhibit "B." Inclusion of property on the Development Plan shall not, under any circumstances, obligate Declarant to subject such property to this Declaration, nor shall the omission of property described in Exhibit

"B" from the Development Plan bar its later submission to this Declaration as provided in Section 9.

2.11 "**Member**": A Person subject to membership in the Association pursuant to Section 6.2.

2.12 "**Mortgage**": A mortgage, a deed of trust, a deed to secure debt, or any other form of security instrument affecting title to any Unit. A "Mortgagee" shall refer to a beneficiary or holder of a Mortgage.

2.13 "**Owner**": One or more Persons who hold the record title to any Unit, but excluding in all cases any party holding an interest merely as security for the performance of an obligation. If a Unit is sold under a Recorded contract of sale, and the contract specifically so provides, the purchaser (rather than the fee owner) will be considered the Owner.

2.14 "**Person**": A natural person, a corporation, a partnership, a trustee, a limited liability company, or any other legal entity.

2.15 "**Record,**" "**Recording,**" or "**Recorded**": To file, filing, or filed of record in the official records of the Cleveland County Clerk, Cleveland County, State of Oklahoma. The date of Recording shall refer to that time at which a document, map, or plat is Recorded.

2.16 "**Special Assessment**": Assessments levied in accordance with Section 8.3.

2.17 "**Specific Assessment**": Assessments levied in accordance with Section 8.4.

2.18 "**Supplemental Declaration**": An instrument Recorded pursuant to Section 9, which accomplishes one or more of the following purposes: (a) subjects additional property to this Declaration, or (b) imposes, expressly or by reference, restrictions and obligations on the land described in such instrument.

2.19 "**Trailwoods**": The real property described in Exhibit "A," together with such additional property as is subjected to this Declaration in accordance with Section 9.

2.20 "**Trailwoods Governing Documents**" or "**Governing Documents**": A collective term referring to this Declaration and any applicable Supplemental Declaration, the By-Laws of the Association, (the "By-Laws"), the Articles of Incorporation of the Association, (the "Articles"), the Use Restrictions and Rules and any design review guidelines promulgated in accordance with Section 4, as they may be amended.

2.21 "**Trailwoods-Wide Standard**": The standard of conduct, maintenance, or other activity generally prevailing throughout Trailwoods. Such standard shall be established initially by Declarant and may be more specifically defined in the Use Restrictions and Rules, Design Review Guidelines, and in Board resolutions, the budget, levels of maintenance and the Association's operation of its facilities.

2.22 "**Unit**": A portion of Trailwoods, whether improved or unimproved, which may be

independently owned and is intended for development, use, and occupancy as an attached or detached residence for a single family. The term shall refer to the land, if any, which is part of the Unit as well as any improvements thereon. In the case of a building within a condominium or other structure containing multiple dwellings, each dwelling shall be deemed to be a separate Unit. In the case of a parcel of vacant land or land on which improvements are under construction, the parcel shall be deemed to contain the number of Units designated for residential use for such parcel on the Development Plan or the site plan approved by Declarant, whichever is more recent, until such time as a subdivision plat or condominium plat is Recorded on all or a portion of the parcel. Thereafter, the portion encompassed by such plat shall contain the number of Units determined as set forth thereon and any portion not encompassed by such plat shall continue to be treated in accordance with this paragraph.

2.23 "Use Restrictions and Rules": The initial use restrictions and rules set forth in Exhibit "C," as they may be supplemented, modified and repealed pursuant to Section 3.

PART TWO: CREATION AND MAINTENANCE OF COMMUNITY STANDARDS

The standards for use, conduct, maintenance, and architecture at Trailwoods give the community its identity and make Trailwoods a place that people want to call "home." The standards are more than simply rules. This Declaration establishes procedures for rulemaking as a dynamic process which allows the community standards to evolve as the community changes and grows and as technology and public perception change.

Section 3 Use and Conduct.

3.1 Framework for Regulation.

Trailwoods Governing Documents establish, as part of the general plan of development for Trailwoods, a framework of affirmative and negative covenants, easements, and restrictions which govern Trailwoods. Within that framework, the Board and the Members must have the ability to respond to unforeseen problems and changes in circumstances, conditions, needs, desires, trends, and technologies which inevitably will affect Trailwoods, its Owners and residents. This Section establishes procedures for modifying and expanding the initial Use Restrictions and Rules set forth in Exhibit "C." Any modification or expansion shall be effective whether or not Recorded. Each Owner is charged with determining the scope, terms, and nature of any restrictions, rules, and design guidelines pertaining to Trailwoods, whether or not such documents are Recorded, provided such document is adopted pursuant to the terms of this Declaration.

3.2 Rule Making Authority.

(1) Subject to the terms of this Section and the Board's duty to exercise business judgment and reasonableness on behalf of the Association and its Members, the Board may modify, cancel, limit, create exceptions to, or expand the Use Restrictions and Rules. The Use Restrictions and Rules may apply to Units, Common Areas, Owners, Persons, and the

Association. The Board shall send notice by mail to all Owners concerning any such proposed action at least five business days prior to the Board meeting at which such action is to be considered. Members shall have a reasonable opportunity to be heard at a Board meeting prior to such action being taken.

Such action shall become effective, after compliance with subsection (3) below, unless disapproved at a meeting by Members representing more than 50% of the total Class "A" votes in the Association and by the Class "B" Member, if any. The Board shall have no obligation to call a meeting of the Members to consider disapproval except upon receipt of a petition of the Members as required for special meetings in the By-Laws.

(2) Alternatively, the Members, at an Association meeting duly called for such purpose, may adopt rules which modify, cancel, limit, create exceptions to, or expand the Use Restrictions and Rules by a vote of Members representing more than 50% of the total Class "A" votes in the Association and the approval of the Class "B" Member, if any.

(3) In an effort to assist any Owner in discharging their duty of inquiry under 3.1, at least 30 days prior to the effective date of any action taken under subsections (1) or (2) of this Section, the Board shall send a copy of the new rule or explanation of any changes to the Use Restrictions and Rules to each Owner specifying the effective date. The Association shall provide, without cost, a copy of the Use Restrictions and Rules then in effect to any requesting Member or Mortgagee. Failure to affirmatively provide a copy of the new rule or explanation of any changes in the Use Restrictions and Rules, unless an Owner, Member, or Mortgagee expressly requests in writing a copy of the same, shall not affect the validity or effect of such rule or explanation thirty days after its adoption.

3.3 Owners' Acknowledgment and Notice to Purchasers.

All Owners are hereby given notice that use of their Units and the Common Area is limited by the Use Restrictions and Rules as they may be amended, expanded and otherwise modified hereunder. Each Owner, by acceptance of a deed, acknowledges and agrees that the use and enjoyment and marketability of such Owner's Unit can be affected by this provision and that the Use Restrictions and Rules may change from time to time. All purchasers of Units are on notice that changes may have been adopted by the Association. Copies of the current Use Restrictions and Rules may be obtained from the Association as provided above.

3.4 Protection of Owners and Others.

Except as may be contained in this Declaration either initially or by amendment or in the initial Use Restrictions and Rules set forth in Exhibit "C," and the Design Review Guidelines set forth in Exhibit "F," all rules shall comply with the following provisions:

(1) **Similar Treatment.** Similarly situated Owners shall be treated similarly; provided, the Design Review Guidelines and Use Restrictions and Rules may vary between additional or annexed properties.

(2) Displays. The rights of Owners to display religious and holiday signs, symbols, and decorations inside structures on their Units of the kinds normally displayed in dwellings located in single-family residential neighborhoods shall not be abridged, except that the Association may adopt time, place, and manner restrictions with respect to displays visible from outside the dwelling. No rules shall unreasonably regulate the content of political signs. The rules may regulate the time, place and manner of posting such signs (including design criteria).

(3) Household Composition. No rule shall interfere with the freedom of Owners to determine the composition of their households, except that the Association shall have the power to require that all occupants be members of a single housekeeping unit and to limit the total number of occupants permitted in each Unit on the basis of the size and facilities of the Unit and such occupants' fair use of the Common Area.

(4) Activities Within Dwellings. No rule shall interfere with the activities carried on within the confines of dwellings, except that the Association may prohibit activities not normally associated with property restricted to residential use, and it may restrict or prohibit any activities that create monetary costs for the Association or other Owners, that create a danger to the health or safety of occupants of other Units, that generate excessive noise or traffic, that create unsightly conditions visible outside the dwelling, or that create an unreasonable source of annoyance.

(5) Alienation. Subject to Exhibit "C" section 4, no rule shall prohibit leasing or transfer of any Unit, or require consent of the Association or Board for leasing or transfer of any Unit; provided, the Association or the Board may require a minimum lease term of up to 12 months. The Association may require that Owners use lease forms approved by the Association, but shall not impose any fee on the lease or transfer of any Unit greater than an amount reasonably based on the costs to the Association of administering that lease or transfer.

(6) Abridging Existing Rights. No rule shall require an Owner to dispose of personal property that was in or on a Unit prior to the adoption of such rule and which was in compliance with all rules previously in force. This dispensation shall apply only for the duration of such Owner's ownership of the Unit personally, and this right shall not run with title to any Unit.

(7) Reasonable Basis. No rule may prohibit any activity, condition, or conduct unless there exists a reasonable basis for the enactment of such rule. For purposes of this subsection, reasonable basis may include, but not be limited to, restrictions as to time, place, and manner of activity or conduct, or concerns relating to safety, fair use of Common Area, cost, aesthetics, or the goals of the comprehensive plan for the development of Trailwoods.

(8) Reasonable Rights to Develop. No rule or action by the Association or Board shall unreasonably impede Declarant's right to develop the Properties.

The limitations in subsections (1) through (8) of this Section shall limit rulemaking authority exercised under Section 3.2 only; they do not limit amendments to this Declaration adopted in accordance with Section 17 or rights retained by the Declarant under Section 9.1.

Section 4 Architecture and Landscaping.

4.1 General.

The Design Review Board (DRB) shall have primary jurisdiction over all matters of design review for all property in Trailwoods. The Design Review Board may, however, delegate some of its powers or responsibilities, with respect to design review for Trailwoods to the Association. Unless and until such time as the Design Review Board delegates all or a portion of its reserved rights to the Association, the Association shall have no jurisdiction over architectural matters. To assist with an Owner's navigation of the design review process and standards, the Design Review Board adopts the Design Review Guidelines as initially set out in Exhibit "F," which may be amended from time to time as provided in Section 1.3 to the Design Review Guidelines. The Declarant shall act as the Design Review Board until the earlier of 1) the termination of the Class B Control Period, or 2) the Declarant by Recorded instrument assigns oversight of the DRB to the Association.

4.2 New Construction.

The DRB shall have exclusive oversight of all new construction within Trailwoods, including but not limited to those elements defined as Modifications. So long as Declarant owns any portion of the property described in Exhibit "A" or Exhibit "B," Declarant, by agreement with the Design Review Board, may establish a higher standard of design review for initial construction for all or a portion of Trailwoods than that which is applicable to other portions of Trailwoods. In such event, Declarant shall administer the design review standards that exceed those imposed by the Design Review Board in accordance with procedures, policies, and standards agreed upon by Declarant and the Design Review Board.

4.3 Modifications.

The DRB shall have exclusive oversight of all modifications to existing construction within Trailwoods, including but not limited to all exterior improvements, structures, and any appurtenances thereto or components thereof of every type and kind, and all landscaping features, including but not limited to buildings, outbuildings, swimming pools, tennis courts, patios, patio covers, awnings, solar panels, painting or other finish materials on any visible surface, additions, walkways, sprinkler systems, garages, carports, driveways, fences, screening walls, retaining walls, stairs, decks, landscaping, hedges, gardens, windbreaks, plantings, trees, shrubs, flowers, vegetables, sod, gravel, bark, exterior lighting, poles, sporting fixtures such as basketball goals, temporary sporting features such as temporary basketball goals, signs, exterior tanks, exterior air conditioning units, cooling, heating, and water softening equipment (Modifications). If the Design Review Board delegates to the Association its design review authority for exterior alterations of existing improvements or planting or removal of landscaping, the Association shall establish an Architectural Review Committee (ARC). The structure, policies, procedures, and standards set forth in this Section shall apply to the ARC unless the Design Review Board otherwise establishes or modifies such matters.

4.4 No Waiver of Future Approvals.

Each Owner acknowledges that the persons reviewing applications under this Section (collectively, the "Reviewer") will change from time to time and that opinions on aesthetic matters, as well as interpretation and application of the Declaration or the Design Review Guidelines, may vary accordingly. In addition, each Owner acknowledges that it may not always be possible to identify objectionable features of proposed activity ("Work") within the scope of this Section until the Work is completed, in which case it may be necessary to require changes to the improvements involved. Approval of applications or Plans for any Work done or proposed, or in connection with any other matter requiring approval, shall not be deemed to constitute a waiver of the right of any Reviewer to withhold approval as to any similar applications, Plans, or other matters subsequently or additionally submitted for approval.

4.5 Variances.

A Reviewer may authorize variances from compliance with any guidelines and procedures (a) in narrow circumstances where the design meets the intent of the provision sought to be varied and where granting of the variance would enhance design innovation and excellence, or (b) when circumstances such as topography, natural obstructions, hardship, or aesthetic or environmental considerations so require, but only in accordance with duly adopted rules and regulations. A variance may be granted only when special circumstances so dictate and no variance shall (a) be effective unless in writing; (b) be contrary to this Declaration; or (c) estop the Reviewer from denying a variance in other circumstances. For purposes of this Section, the inability to obtain approval of any governmental agency, issuance of any permit, or the terms of any financing shall not constitute hardships.

4.6 Limitation of Liability.

The standards and procedures established by this Section are intended as a mechanism for maintaining and enhancing the overall aesthetics of Trailwoods; they do not create any duty to any Person. Review and approval of any application pursuant to this Section are made on the basis of aesthetic considerations only, and the Reviewer shall not bear any responsibility for ensuring (i) structural integrity or soundness of approved construction or modifications, (ii) compliance with building codes and other governmental requirements; or (iii) conformity of quality, value, size or design among Units.

Declarant, the Design Review Board, the Association, the Board, and any committee, or member of any of the foregoing shall not be held liable for soil conditions, drainage or other general site work, or for any defects in plans revised or approved hereunder, or for any injury, damages, or loss arising out of the manner or quality of approved construction or modifications to any Unit. In all matters, the Reviewer shall be defended and indemnified by the Association as provided in Section 7.6.

4.7 Certificate of Compliance.

Any Owner may request that the Reviewer issue a Certificate of Architectural

Compliance certifying that there are no known violations of this Section or the Declaration. The Association shall either grant or deny such request within 30 days after receipt of a written request and may charge a reasonable administrative fee for issuing such certificates. Issuance of such a certificate shall estop the Association from taking enforcement action with respect to any condition as to which the Association had notice as of the date of such certificate.

4.8 Fees; Assistance.

The Reviewer may establish and charge reasonable fees for review of applications hereunder and may require such fees to be paid in full prior to review of any application. Such fees may include the reasonable costs incurred in having any application reviewed by architects, engineers or other professionals. Declarant and the Association may employ architects, engineers, or other persons as deemed necessary to perform the review. The Board may include the compensation of such persons in the Association's annual operating budget as a Common Expense.

4.9 Declarant, Design Review Board, and ARC Addresses.

For purposes of this Section 4, Owners shall submit applications to each of the following addresses in the following forms:

Trailwoods Declarant

Attn: Architectural Application
2400 Sharpish Road
Norman, Oklahoma 73071

Trailwoods Design Review Board

Attn: Architectural Application
2400 Sharpish Road
Norman, Oklahoma 73071

Any change in the above notice addresses shall be given through a filing in the real property records of Cleveland County, State of Oklahoma designated a "Change of Address for Design Applications" providing both the entity and new address for submission of applications.

Section 5 Maintenance and Repair.

5.1 Maintenance of Units.

Each Owner shall maintain such Owner's Unit, including all landscaping and improvements comprising the Unit, in a manner consistent with Trailwoods Governing Documents, Trailwoods-Wide Standard and all applicable covenants, unless, such maintenance responsibility is otherwise assumed by or assigned to the Association pursuant to any Supplemental Declaration or other declaration of covenants applicable to such Unit.

5.2 Responsibility for Repair and Replacement.

Unless otherwise specifically provided in Trailwoods Governing Documents or in other instruments creating and assigning maintenance responsibility, responsibility for maintenance shall include responsibility for repair and replacement, as necessary to maintain the property to a level consistent with Trailwoods-Wide Standard.

By virtue of taking title to a Unit, each Owner covenants and agrees with all other Owners and with the Association to carry property insurance for the full replacement cost of all insurable improvements on such Owner's Unit, less a reasonable deductible. If the Association assumes responsibility for obtaining any insurance coverage on behalf of Owners, the premiums for such insurance shall be levied as a Specific Assessment against the benefited Unit and the Owner.

Each Owner further covenants and agrees that in the event of damage to or destruction of structures on or comprising such Owner's Unit, the Owner shall proceed promptly to repair or to reconstruct in a manner consistent with the original construction or such other plans and specifications as are approved in accordance with Section 4. Alternatively, the Owner shall clear the Unit and maintain it in a neat and attractive, landscaped condition consistent with Trailwoods-Wide Standard. The Owner shall pay any costs which are not covered by insurance proceeds.

PART THREE: COMMUNITY GOVERNANCE AND ADMINISTRATION

The success of Trailwoods is dependent upon the support and participation of every Owner in its governance and administration. The Declaration establishes the Association as the mechanism by which each owner is able to provide that support and participation. While many powers and responsibilities are vested in the Association's Board of Directors, some decisions are reserved for the Association's membership – the owners of property in Trailwoods.

Section 6 The Association and its Members.

6.1 Function of Association.

The Association is the entity responsible for management, maintenance, operation and control of the Common Area. The Association also is the primary entity responsible for enforcement of Trailwoods Governing Documents. The Association shall perform its functions in accordance with Trailwoods Governing Documents and the laws of the State of Oklahoma.

6.2 Membership.

Every Owner is a Member of the Association. There is only one membership per Unit. If a Unit is owned by more than one Person, all co-Owners shall share the privileges of such membership, subject to reasonable Board regulation and the restrictions on voting set forth in Section 6.3(3) and in the By-Laws, and all such co-Owners shall be jointly and severally obligated to perform the responsibilities of Owners. The membership rights of an Owner which is not a natural person may be exercised by any officer, director, partner or trustee, or by the

individual designated from time to time by the Owner in writing provided to the Secretary of the Association.

6.3 Voting.

The Association shall have two classes of membership, Class "A" and Class "B."

(1) **Class "A"**. Class "A" Members shall be all Owners except the Class "B" Member, if any. Class "A" Members shall have one equal vote for each Unit in which they hold the interest required for membership under Section 6.2, except that there shall be only one vote per Unit and no vote shall be exercised for any property which is exempt from assessment under Section 8.8. All Class "A" votes shall be cast as provided in Section 6.3(3) below.

(2) **Class "B"**. The sole Class "B" Member shall be Declarant. The Class "B" Member may appoint members of the Board of Directors during the Class "B" Control Period, as specified in Section 3 of the By-Laws. Additional rights of the Class "B" Member are specified in the relevant sections of Trailwoods Governing Documents. After termination of the Class "B" Control Period, the Class "B" Member shall have a right to disapprove actions of the Board and committees as provided in Section 3.19 of the By-Laws.

The Class "B" membership shall terminate upon the earlier of:

(i) expiration or termination of the addition and annexation rights reserved to the Declarant in Section 9.1 to this Declaration; or

(ii) when, in its discretion, Declarant so determines and declares in a Recorded instrument.

Upon termination of the Class "B" membership, Declarant shall be a Class "A" Member entitled to one Class "A" vote for each Unit which it owns.

(3) **Exercise of Voting Rights**. Except as otherwise specified in this Declaration or the By-Laws, the vote for each Unit owned by a Class "A" Member shall be exercised by the Member representing the Unit. The Member may cast all such votes as it, in its discretion, deems appropriate.

In any situation where a Member is entitled personally to exercise the vote for such Member's Unit, and there is more than one Owner of such Unit, the vote for such Unit shall be exercised as the co-Owners determine among themselves and advise the Secretary of the Association in writing prior to the vote being taken. Absent such advice, the Unit's vote shall be suspended if more than one Person seeks to exercise such vote; however the Unit shall be counted for quorum purposes.

Section 7 Association Powers and Responsibilities

7.1 Acceptance and Control of Association Property.

The Association, through action of its Board, may acquire, hold, and dispose of tangible and intangible personal property and real property. Declarant and its designees may convey to the Association personal property and fee title, leasehold or other property interests in any real property, improved or unimproved, described in Exhibits "A" or "B." The Association shall accept and maintain such property at its expense for the benefit of its Members, subject to any restrictions set forth in the deed or other instrument transferring such property to the Association. Upon written request of Declarant, the Association shall re-convey to Declarant any unimproved portions of Trailwoods originally conveyed by Declarant to the Association for no consideration, to the extent conveyed by Declarant in error or needed by Declarant to make minor adjustments in property lines.

The Declarant shall not bear any responsibility for any damages caused by mold, or by some other agent, that may be associated with defects in Common Area improvements and construction, to include but not be limited to property damage, personal injury, loss of income, emotional distress, death, loss of use, loss of value, and adverse health effects, or any other effects. Any implied warranties, including an implied warranty of workmanlike construction, an implied warranty of habitability, or an implied warranty of fitness for a particular use, are hereby waived and disclaimed.

7.2 Maintenance of Common Areas.

The Association shall maintain, in accordance with Trailwoods-Wide Standard and the business judgment rule, the Common Area, which shall include, but need not be limited to:

- (i) all portions of and structures situated upon the Common Area;
- (ii) landscaping within public rights-of-way within or abutting Trailwoods;
- (iii) such portions of any additional property included within the Common Area as may be dictated by this Declaration, any Supplemental Declaration, or any contract or agreement for maintenance thereof entered into by the Association;
- (iv) all areas located within Trailwoods which serve as part of the stormwater drainage system for Trailwoods, including improvements and equipment installed therein or used in connection therewith; provided, neither Declarant, the Design Review Board, nor the Association shall have any liability for damage or injury caused by flooding or surface runoff resulting from rainfall or other natural occurrences; and
- (v) any property and facilities owned by Declarant and made available, on a temporary or permanent basis, for the primary use and enjoyment of the Association and its Members, such property and facilities to be identified by written notice from Declarant to the Association and to remain a part of the Common Area and be maintained by the Association until such time as Declarant revokes such privilege of use and enjoyment by written notice to the Association.

The Association shall have the right to enter upon, for the purpose of maintaining, and may maintain other property which it does not own, including, without limitation, property dedicated to the public, if the Board of Directors determines that such maintenance is necessary or desirable to maintain Trailwoods-Wide Standard.

The Association shall not be liable for any damage or injury occurring on, or arising out

of the condition of, property which it does not own, except to the extent that it has been negligent in the performance of its maintenance responsibilities.

The Association shall maintain the facilities and equipment within the Common Area in continuous operation, except for any periods necessary, as determined in the sole discretion of the Board, to perform required maintenance or repairs, unless Members representing 75% of the Class "A" votes in the Association and the Class "B" Member, if any, agree in writing to discontinue such operation.

Except as provided above, the Common Area shall not be reduced by amendment of this Declaration or any other means except with the prior written approval of Declarant as long as Declarant owns any property described in Exhibits "A" or "B" of this Declaration.

The costs associated with maintenance, repair, and replacement of the Common Area shall be a Common Expense; provided, the Association may seek reimbursement from the owner(s) of, or other Persons responsible for, certain portions of the Properties pursuant to this Declaration, other Recorded covenants, or agreements with the owner(s) thereof.

7.3 Insurance.

7.3.1 Required Coverages. The Association, acting through its Board or its duly authorized agent, shall obtain and continue in effect the following types of insurance, if reasonably available, or if not reasonably available, the most nearly equivalent coverages as are reasonably available:

(1) Blanket property insurance covering "risks of direct physical loss" on a "special form" basis (or comparable coverage by whatever name denominated) for all insurable improvements on the Common Area to the extent that Association has assumed responsibility in the event of a casualty, regardless of ownership. If such coverage is not generally available at reasonable cost, then "broad form" coverage may be substituted. All property insurance policies obtained by the Association shall have policy limits sufficient to cover the full replacement cost of the insured improvements under current building ordinances and codes;

(2) Commercial general liability insurance on the Common Area, insuring the Association and its Members for damage or injury caused by the negligence of the Association or any of its Members, employees, agents, or contractors while acting on its behalf. If generally available at reasonable cost, such coverage (including primary and any umbrella coverage) shall have a limit of at least \$1,000,000.00 per occurrence with respect to bodily injury, personal injury, and property damage; provided, should additional coverage and higher limits be available at reasonable cost which a reasonably prudent person would obtain, the Association shall obtain such additional coverages or limits;

(3) Workers compensation insurance and employers liability insurance, if and to the extent required by law;

(4) Directors and officers liability coverage;

(5) Commercial crime insurance, including fidelity insurance covering all Persons responsible for handling Association funds in an amount determined in the Board's business judgment but not less than an amount equal to one-sixth of the annual Base Assessments on all Units plus reserves on hand. Fidelity insurance policies shall contain a waiver of all defenses based upon the exclusion of Persons serving without compensation; and

(6) Such additional insurance as the Board, in its business judgment, determines advisable.

Premiums for all insurance on the Common Area shall be Common Expenses

7.3.2 Policy Requirements. The Association shall arrange for an annual review of the sufficiency of its insurance coverage by one or more qualified Persons, at least one of whom must be familiar with insurable replacement costs in the metropolitan Norman area. All Association policies shall provide for a certificate of insurance to be furnished to the Association and, upon request, to each Member insured.

The policies may contain a reasonable deductible and the amount thereof shall not be subtracted from the face amount of the policy in determining whether the policy limits satisfy the requirements of Section 7.3.1. In the event of an insured loss, the deductible shall be treated as a Common Expense in the same manner as the premiums for the applicable insurance coverage. However, if the Board reasonably determines, after notice and an opportunity to be heard in accordance with Section 3.24 of the By-Laws, that the loss is the result of the negligence or willful misconduct of one or more Owners, their guests, invitees, or lessees, then the Board may assess the full amount of such deductible against such Owner(s) and their Units as a Specific Assessment.

7.3.2.1 Additional Policy Requirements. All insurance coverage obtained by the Board, to the extent reasonably possible, shall:

(1) be written with a company authorized to do business in the State of Oklahoma which satisfies the requirements of the Federal National Mortgage Association, or such other secondary mortgage market agencies or federal agencies as the Board deems appropriate;

(2) be written in the name of the Association as trustee for the benefited parties. Policies on the Common Areas shall be for the benefit of the Association and its Members;

(3) not be brought into contribution with insurance purchased by Owners, occupants, or their Mortgagees individually;

(4) contain an inflation guard endorsement;

(5) include an agreed amount endorsement, if the policy contains a co-insurance clause;

(6) provide that each Owner is an insured person under the policy with respect to liability

arising out of such Owner's interest in the Common Area as a Member in the Association (provided, this provision shall not be construed as giving an Owner any interest in the Common Area other than that of a Member);

(7) provide a waiver of subrogation under the policy against any Owner or household member of an Owner;

(8) include an endorsement precluding cancellation, invalidation, suspension, or non-renewal by the insurer on account of any one or more individual Owners, or on account of any curable defect or violation without prior written demand to the Association to cure the defect or violation and allowance of a reasonable time to cure; and

(9) include an endorsement precluding cancellation, invalidation, or condition to recovery under the policy on account of any act or omission of any one or more individual Owners, unless such Owner is acting within the scope of its authority on behalf of the Association.

7.3.2.2 Desirable Policy Components. In addition, the Board shall use reasonable efforts to secure insurance policies which list the Owners as additional insureds and provide:

(1) a waiver of subrogation as to any claims against the Association's Board, officers, employees, and its manager, the Owners and their tenants, servants, agents, and guests;

(2) a waiver of the insurer's rights to repair and reconstruct instead of paying cash;

(3) an endorsement excluding Owners' individual policies from consideration under any "other insurance" clause;

(4) an endorsement requiring at least 30 days' prior written notice to the Association of any cancellation, substantial modification, or non-renewal;

(5) a cross liability provision; and

(6) a provision vesting in the Board exclusive authority to adjust losses; provided, however, no Mortgagee having an interest in such losses may be prohibited from participating in the settlement negotiations, if any, related to the loss.

7.3.3 Restoring Damaged Improvements. In the event of damage to or destruction of Common Area or other property which the Association is obligated to insure, the Board or its duly authorized agent shall file and adjust all insurance claims and obtain reliable and detailed estimates of the cost of repairing or restoring the property to substantially the condition in which it existed prior to the damage, allowing for changes or improvements necessitated by changes in applicable building codes.

Damaged improvements on the Common Area shall be repaired or reconstructed unless the Members representing at least 75% of the total Class "A" votes in the Association, and the Class "B" Member, if any, decide within 60 days after the loss not to repair or reconstruct. If

either the insurance proceeds or estimates of the loss, or both, are not available to the Association within such 60-day period, then the period shall be extended until such funds or information are available. However, such extension shall not exceed 60 additional days. No Mortgagee shall have the right to participate in the determination of whether the damage or destruction to the Common Area shall be repaired or reconstructed.

If a decision is made not to restore the damaged improvements, and no alternative improvements are authorized, the affected property shall be cleared of all debris and ruins and thereafter shall be maintained by the Association in a neat and attractive landscaped condition consistent with Trailwoods- Wide Standard.

Any insurance proceeds remaining after paying the costs of repair or reconstruction, or after such settlement as is necessary and appropriate, shall be retained by the Association for the benefit of its Members, and placed in a capital improvements account. This is a covenant for the benefit of Mortgagees and may be enforced by the Mortgagee of any affected Unit.

If insurance proceeds are insufficient to cover the costs of repair or reconstruction, the Board may, without a vote of the Members, levy Special Assessments to cover the shortfall against those Owners responsible for the premiums for the applicable insurance coverage under Section 7.3.1.

7.4 Compliance and Enforcement.

Every Owner and occupant of a Unit shall comply with Trailwoods Governing Documents. The Board may impose sanctions for violation of Trailwoods Governing Documents after notice and a hearing in accordance with the procedures set forth in Section 3.24 of the By-Laws. Such sanctions may include, without limitation:

(1) imposing reasonable monetary fines which shall constitute a lien upon the violator's Unit. (In the event that any occupant, guest or invitee of a Unit violates Trailwoods Governing Documents and a fine is imposed, the fine shall first be assessed against the violator, but if the fine is not paid by the violator within the time period set by the Board, the Owner shall pay the fine upon notice from the Board);

(2) suspending an Owner's right to vote in all matters;

(3) suspending any Person's right to use any recreational facilities within the Common Area; provided, however, nothing herein shall authorize the Board to limit ingress or egress to or from a Unit;

(4) suspending any services provided by the Association to an Owner or the Owner's Unit if the Owner is more than 30 days delinquent in paying any assessment or other charge owed to the Association;

(5) exercising self-help or taking action to abate any violation of Trailwoods Governing Documents in a non-emergency situation;

(6) requiring an Owner, at the Owner's expense, to remove any structure or improvement on such Owner's Unit in violation of Section 4 and to restore the Unit to its previous condition and, upon failure of the Owner to do so, the Board or its designee shall have the right to enter the property, remove the violation and restore the property to substantially the same condition as previously existed and any such action shall not be deemed a trespass;

(7) without liability to any Person, prohibiting any contractor, subcontractor, agent, employee or other invitee of an Owner who fails to comply with the terms and provisions of Section 4 from continuing or performing any further activities in Trailwoods; and

(8) levying Specific Assessments to cover costs incurred by the Association to bring a Unit into compliance with Trailwoods Governing Documents.

In addition, the Board may take the following enforcement procedures to ensure compliance with Trailwoods Governing Documents without the necessity of compliance with the procedures set forth in Section 3.24 of the By-Laws; exercising self-help in any emergency situation (specifically including, but not limited to, the towing of vehicles that are in violation of parking rules and regulations); and bringing suit at law or in equity to enjoin any violation or to recover monetary damages or both.

In addition to any other enforcement rights, if an Owner fails properly to perform such Owner's maintenance responsibility, the Association may Record a notice of violation or perform such maintenance responsibilities and assess all costs incurred by the Association against the Unit and the Owner as a Specific Assessment. Except in an emergency situation, determined in the sole discretion of the Board, the Association shall provide the Owner with reasonable notice and an opportunity to cure the problem prior to taking such enforcement action.

All remedies set forth in Trailwoods Governing Documents shall be cumulative of any remedies available at law or in equity. In any action to enforce Trailwoods Governing Documents, if the Association prevails, it shall be entitled to recover all costs, including, without limitation, attorneys fees and court costs, reasonably incurred in such action.

The Association shall not be obligated to take any action if the Board reasonably determines that the Association's position is not strong enough to justify taking such action. Such a decision shall not be construed a waiver of the right of the Association to enforce such provision at a later time under other circumstances or estop the Association from enforcing any other covenant, restriction or rule.

The Association, by agreement, may, but shall not be obligated to, enforce applicable city and county ordinances, and may, but shall not be obligated to, permit Cleveland County or the City of Norman to enforce ordinances within Trailwoods Properties for the benefit of the Association and its Members.

While conducting the business affairs of the Association, the Board shall act within the scope of Trailwoods Governing Documents and in good faith to further the legitimate interests of

the Association and its Members. In fulfilling its governance responsibilities, the Board's actions shall be governed and tested by the rule of reasonableness. The Board shall exercise its power in a fair and nondiscriminatory manner and shall adhere to the procedures established in Trailwoods Governing Documents.

7.5 Implied Rights; Board Authority.

The Association may exercise any right or privilege expressly given to the Association by Trailwoods Governing Documents, or reasonably implied from or reasonably necessary to effectuate any such right or privilege. Except as otherwise specifically provided in Trailwoods Governing Documents, or by law, all rights and powers of the Association may be exercised by the Board without a vote of the membership.

7.6 Indemnification of Officers, Directors and Others.

Subject to Oklahoma law, the Association shall indemnify every officer, director, and committee member, including the Design Review Board and Architectural Review Committee against all damages and expenses, including legal fees, reasonably incurred in connection with any claim, action, suit, or other proceeding (including settlement of any suit or proceeding, if approved by the then Board of Directors) to which he or she may be a party by reason of being or having been an officer, director, or committee member, except that such obligation to indemnify shall be limited to those actions for which liability is limited under this Section.

The officers, directors, and committee members shall not be liable for any mistake of judgment, negligent or otherwise, except for their own individual willful misfeasance, malfeasance, misconduct, or bad faith. The officers and directors shall have no personal liability with respect to any contract or other commitment made or action taken in good faith on behalf of the Association (except to the extent that such officers or directors may also be Members of the Association).

The Association shall indemnify and forever hold each such officer, director, and committee member harmless from any and all liability to others on account of any such contract, commitment, or action. This right to indemnification shall not be exclusive of any other rights to which any present or former officer, director, or committee member may be entitled. The Association shall, as a Common Expense, maintain adequate general liability and officers' and directors' liability insurance to fund this obligation, if such insurance is reasonably available.

7.7 Security.

The Association may, but shall not be obligated to, maintain or support certain activities at Trailwoods designed to enhance the security of Trailwoods. Neither the Association nor Declarant are insurers or guarantors of security at Trailwoods, nor shall either be held liable for any loss or damage by reason of failure to provide adequate security or ineffectiveness of security measures undertaken.

The Association and Declarant make no representation or warranty that any

systems or measures, including any mechanism or system for limiting access to Trailwoods, cannot be compromised or circumvented, or that any such systems or security measures undertaken will in all cases prevent loss or provide the detection or protection for which the system is designed or intended. Each Owner acknowledges, understands and covenants to inform its tenants and all occupants of its Unit that the Association, its Board and committee members, and Declarant are not insurers and that each Person at Trailwoods assumes all risks of personal injury and loss or damage to property, including Units and the contents of Units, resulting from acts of third parties.

7.8 Provision of Services.

The Board may enter into and terminate contracts or agreements with other entities, including Declarant, to provide services to and facilities for the Members and their guests, lessees and invitees; the Board may charge use and consumption fees for such services and facilities. By way of example, some services and facilities which might be offered include landscape maintenance, pest control service, cable television service, security, caretaker, transportation, fire protection, utilities, and similar services and facilities.

7.9 Facilities and Services Open to the Public.

Certain facilities and areas within the Common Area may be open for the use and enjoyment of the public. Such facilities and areas may include, by way of example: greenbelts, trails and paths, a town center, parks and other neighborhood spots at which to gather and interact, and roads, sidewalks, medians, and parking lots. Declarant may designate such areas and facilities as open to the public at the time Declarant makes such facilities or areas a part of the Common Area or the Board may so designate at any time thereafter.

7.10 Association's Responsibility with Respect to Transfer of Units.

If required by law, the Association shall furnish to the purchaser of a Unit, within seven days after receipt of notice of a pending sale of the Unit given in accordance with Section 15, a copy of the Governing Documents, if not otherwise received by the purchaser in connection with such sale, and a dated document containing the following:

- (1) the telephone number and address of a principal contact for the Association, as designated by the Board;
- (2) the amount of all assessments, fees, or charges then owed by the seller of the Unit;
- (3) a statement regarding whether any portion of the subject Unit is covered by insurance the Association maintains;
- (4) a statement regarding whether the Association has any knowledge of any alterations or improvements to the Unit that violate any provision of this Declaration;
- (5) a statement as to whether the Association has knowledge of any violations of local health or building codes with respect to the Unit; and
- (6) a statement of case names and case numbers for pending litigation with respect to the Unit filed by the Association against the Member or filed by the Member against the Association.

The Association may charge a fee to cover the costs the Association incurs in preparing any document required by this Section.

Section 8 Association Finances.

8.1 Budgeting and Allocating Common Expenses.

Prior to or contemporaneous with the invoicing of assessments, the Board shall prepare a budget of the estimated Common Expenses for the coming year, including any contributions to be made to a reserve fund pursuant to Section 8.2. The budget shall also reflect the sources and estimated amounts of funds to cover such expenses, which may include any surplus to be applied from prior years, any income expected from sources other than assessments levied against the Units, and the amount to be generated through the levy of Base Assessments and Special Assessments against the Units, as authorized in Section 8.5.

The Association is hereby authorized to levy Base Assessments, in accordance with the initial amounts set forth in Exhibit "E," or by some other formula, against all Units subject to assessment under Section 8.5 to fund the Common Expenses. In determining the Base Assessment rate per Unit, the Board may consider any assessment income expected to be generated from any additional Units reasonably anticipated to become subject to assessment during the fiscal year.

The Board shall send a copy of the final budget, together with notice of the amount of the Base Assessment to be levied pursuant to such budget, to each Owner. There shall be no obligation to call a meeting for the purpose of considering the budget except on petition of the Members as provided for special meetings in Section 2.4 of the By-Laws, which petition must be presented to the Board within 10 days after delivery of the budget and notice of any assessment.

If any proposed budget is disapproved or the Board fails for any reason to determine the budget for any year, then the budget most recently in effect shall continue in effect until a new budget is determined.

The Board may revise the budget and adjust the Base Assessment from time to time during the year, subject to the notice requirements and the right of the Members to disapprove the revised budget as set forth above. Notwithstanding any provision to the contrary, the Board may, in its sole discretion, increase the Base Assessment, provided such increase is uniform to all Units and is no greater than twenty percent (20%) in any fiscal year.

8.2 Budgeting for Reserves.

The Board shall prepare and review at least annually reserve budgets for, respectively the Common Area. The budgets shall take into account the number and nature of replaceable assets, the expected life of each asset, and the expected repair or replacement cost. The Board shall include in the Common Expense budget adopted pursuant to Section 8.1, capital contributions to fund reserves in amounts sufficient to meet projected needs with respect both to amount and timing by annual contributions over the applicable budget period.

8.3 Special Assessments.

In addition to other authorized assessments, the Association may levy Special Assessments to cover unbudgeted expenses or expenses in excess of the amount budgeted. Any such Special Assessment may be levied against the entire membership. The Association shall levy any Special Assessment in accordance with the formula set forth in Exhibit "E." Except as otherwise specifically provided in this Declaration, any Special Assessment shall require the affirmative vote or written consent of Members representing more than 50% of the total votes allocated to Units which will be subject to such Special Assessment, and the affirmative vote or written consent of the Class "B" Member, if such exists. Special Assessments shall be payable in such manner and at such times as determined by the Board, and may be payable in installments extending beyond the fiscal year in which the Special Assessment is approved.

8.4 Specific Assessments.

The Association shall have the power to levy Specific Assessments against a particular Unit as follows:

(1) to cover the costs, including overhead and administrative costs, of providing services to a Unit upon request of an Owner pursuant to any menu of special services which may be offered by the Association (which might include the items identified in Section 7.9). Specific Assessments for special services may be levied in advance of the provision of the requested service; and

(2) to cover costs incurred in bringing a Unit into compliance with Trailwoods Governing Documents, or costs incurred as a consequence of the conduct of the Owner or occupants of a Unit, their agents, contractors, employees, licensees, invitees, or guests; provided, the Board shall give the Unit Owner prior written notice and an opportunity for a hearing, in accordance with Section 3.24 of the By-Laws, before levying any Specific Assessment under this subsection (2).

8.5 Authority To Assess Owners; Time of Payment.

Declarant hereby establishes and the Association is hereby authorized to levy assessments as provided for in this Section and elsewhere in Trailwoods Governing Documents. The obligation to pay assessments shall commence on a date determined in the sole discretion of the Declarant.

Assessments shall be paid in such manner and on such dates as the Board may establish. The Board may require advance payment of assessments at the closing of the transfer of title to a Unit and impose special requirements for Owners with a history of delinquent payment. If the Board so elects, assessments may be paid in two or more installments. Unless the Board otherwise provides, the Base Assessment shall be due and payable in advance on the first day of each fiscal year. If any Owner is delinquent in paying any assessments or other charges levied on his Unit, the Board may require the outstanding balance on all assessments to be paid in full immediately.

8.6 Obligation for Assessments.

8.6.1 Personal Obligation. Each Owner, by accepting a deed or entering into a Recorded contract of sale for any portion of Trailwoods, is deemed to covenant and agree to pay all assessments authorized in Trailwoods Governing Documents. All assessments, together with interest (computed from its due date at a rate of 10% per annum or such higher rate as the Board may establish, subject to the limitations of Oklahoma law), late charges as determined by Board resolution, costs, and reasonable attorneys' fees, shall be the personal obligation of each Owner and a lien upon each Unit until paid in full. Upon a transfer of title to a Unit, the grantee shall be jointly and severally liable for any assessments and other charges due at the time of conveyance.

Failure of the Board to fix assessment amounts or rates or to deliver or mail each Owner an assessment notice shall not be deemed a waiver, modification, or a release of any Owner from the obligation to pay assessments. In such event, each Owner shall continue to pay Base Assessments on the same basis as during the last year for which an assessment was made, if any, until a new assessment is levied, at which time the Association may retroactively assess any shortfalls in collections.

No Owner may exempt themselves from liability for assessments by non-use of Common Area, abandonment of a Unit, or any other means. The obligation to pay assessments is a separate and independent covenant on the part of each Owner. No diminution or abatement of assessments or set-off shall be claimed or allowed for any alleged failure of the Association to take some action or perform some function required of it, or for inconvenience or discomfort arising from the making of repairs or improvements, or from any other action it takes.

The Association shall, upon written request from an Owner, Mortgagee, or other Person designated by the Owner, furnish a certificate, in recordable form, signed by an officer of the Association setting forth whether assessments for such Owner's Unit have been paid and any delinquent amount. Such certificate shall be binding upon the Association, the Board, and the Owners. If the Association fails to provide such certificate within seven business days of its receipt of a written request, any lien for unpaid assessments then due shall be extinguished, if Oklahoma law requires extinguishment in such case. The Association may require the advance payment of a reasonable processing fee for the issuance of such certificate.

8.7 Lien for Assessments.

All assessments and other charges of the Association authorized in this Section or elsewhere in this Declaration shall constitute a lien against the Unit against which they are levied from the time such assessments or charges become delinquent until paid. The lien shall also secure payment of interest (subject to the limitations of Oklahoma law), late charges (subject to the limitations of Oklahoma law), and costs of collection (including attorneys' fees, lien fees and administrative costs). Such lien shall be superior to all other liens, except those deemed by Oklahoma law to be superior. The Association may enforce such lien, when any assessment or other charge is delinquent, by suit, judgment, and foreclosure.

The Association may bid for the Unit at the foreclosure sale and acquire, hold, lease, mortgage, and convey the Unit. While a Unit is owned by the Association following foreclosure: (a) no right to vote shall be exercised on its behalf; (b) no assessment shall be levied on it; and (c) each other Unit shall be charged, in addition to its usual assessment, its pro rata share of the assessment that would have been charged such Unit had it not been acquired by the Association. The Association may sue for unpaid assessments and other charges authorized hereunder without foreclosing or waiving the lien securing the same.

The sale or transfer of any Unit shall not affect the assessment lien or relieve such Unit from the lien for any subsequent assessments. However, the sale or transfer of any Unit pursuant to foreclosure of the first Mortgage shall extinguish the lien as to any installments of such assessments due prior to the Mortgagee's foreclosure. The subsequent Owner to the foreclosed Unit shall not be personally liable for assessments on such Unit due prior to such acquisition of title. Such unpaid assessments shall be deemed to be Common Expenses collectible from Owners of all Units subject to assessment under Section 8.6, including such acquirer, its successors and assigns.

Notwithstanding any other provision of this Declaration, no governmental authority or public utility shall be liable for assessments on any Unit dedicated to and accepted by the governmental authority or public utility ("Dedicated Property") which arose prior to its acceptance of such Unit. Dedicated Property shall include, without limitation, such areas created by or dedicated in the form of easements, including, perpetual easements, tract easements, and easements in favor of the City of Norman or municipal use property.

If only a portion of a Unit is Dedicated Property, any assessments which arose prior to the dedication shall remain due and owing against the non-dedicated portion of the Unit. If the entire Unit is Dedicated Property, such unpaid assessments shall be deemed to be Common Expenses collectible from owners of all Units subject to assessment under Section 8.5.

In the event that a lien exists on any Dedicated Property, (a) if only a portion of the Unit is Dedicated Property, the lien shall remain in effect with respect to the undedicated portion of the Unit and shall terminate with respect to the Dedicated Property, or (b) if the entire Unit is Dedicated Property, the lien shall terminate with respect to the entire Unit.

8.8 Exempt Property.

Notwithstanding any provision to the contrary in the Governing Documents, the following property shall be exempt from payment of Base Assessments, and Special Assessments:

(1) All Common Area and such portions of the property owned by Declarant as are included in the Common Area pursuant to Section 7.2;

(2) Any and all Dedicated Property including, without limitation such areas created by or dedicated in the form of easements, including, perpetual easements, tract easements, and easements in favor of the City of Norman, or property identified on the Development Plan as

municipal use property; and

(3) All property held by the Declarant, its successors, and its assigns, provided further that the Declarant, its successors, and its assigns shall also be exempt from Specific Assessments, and Reserve Assessments.

In addition, Declarant and/or the Association shall have the right, but not the obligation, to grant exemptions to certain Persons qualifying for tax exempt status under Section 501(c) of the Internal Revenue Code so long as such Persons own property subject to this Declaration for purposes listed in Section 501(c).

Dedicated Property also shall be exempt from the payment of Specific Assessments.

8.9 Limitation on Increases of Assessments.

Notwithstanding any provision to the contrary, the Board may not impose an assessment increase exceeding that allowable under Oklahoma law.

PART FOUR: COMMUNITY DEVELOPMENT

The Declaration reserves various rights to Declarant in order to facilitate the smooth and orderly development of Trailwoods and to accommodate changes in the Development Plan which inevitably occur as Trailwoods grows and matures.

Section 9 Expansion of Trailwoods

9.1 Expansion by Declarant.

Declarant may from time to time subject to the provisions of this Declaration all or any portion of the property described in Exhibits "A" or "B" by Recording a Supplemental Declaration describing the additional property to be subjected. A Supplemental Declaration Recorded pursuant to this Section shall not require the consent of any Person except the owner of such property, if other than Declarant.

Declarant's right to expand Trailwoods pursuant to this Section shall expire when all of the property described in Exhibits "A" or "B" has been subjected to this Declaration or 40 years after the Recording of the last Recorded Declaration or Supplemental Declaration whichever is earlier. Until then, Declarant may transfer or assign this right to annex property to any Person who is a purchaser of any portion of the real property described in Exhibits "A" or "B." Declarant shall memorialize such transfer in a Recorded instrument.

Nothing in this Declaration shall be construed to require Declarant or any successor to subject additional property to this Declaration or to develop any of the property described in Exhibits "A" or "B" in any manner whatsoever.

9.2 Expansion by the Association.

The Association may subject additional property to the provisions of this Declaration by Recording a Supplemental Declaration describing the additional property. Any such Supplemental Declaration shall require the affirmative vote of Members representing more than 50% of the Class "A" votes of the Association represented at a meeting duly called for such purpose and the consent of the owner of the property. In addition, so long as Declarant owns property subject to this Declaration or which may become subject to this Declaration in accordance with Section 9.1, the consent of Declarant shall be necessary. The Supplemental Declaration shall be signed by the President and Secretary of the Association, by the owner of the property and by Declarant, if Declarant's consent is necessary.

9.3 Additional Covenants and Easements.

Declarant may subject any portion of Trailwoods to additional covenants and easements, including covenants obligating the Association to maintain and insure such property and authorizing the Association to recover its costs through assessments. Such additional covenants and easements may be set forth either in a Supplemental Declaration subjecting such property to this Declaration or in a separate Supplemental Declaration referencing property previously subjected to this Declaration. If the property is owned by someone other than Declarant, then the consent of the Owner(s) shall be necessary and shall be evidenced by their execution of the Supplemental Declaration. Any such Supplemental Declaration may supplement, create exceptions to, or otherwise modify the terms of this Declaration as it applies to the subject property in order to reflect the different character and intended use of such property.

9.4 Effect of Recording Supplemental Declaration.

A Supplemental Declaration shall be effective upon Recording unless otherwise specified in such Supplemental Declaration. On the effective date of the Supplemental Declaration, any additional property subjected to this Declaration shall be assigned voting rights in the Association and assessment liability in accordance with the provisions of this Declaration.

9.5 Condominium Conversions.

In the event that any property now or hereafter subjected to the Declaration and located within the property described in Exhibits "A" or "B" is converted to a condominium, the owner of such property, subject to Declarant's approval requirements below, shall, subject such property to the provisions of this Declaration by Recording a Supplemental Declaration describing the property and specifically subjecting it to the terms of this Declaration. Such Supplemental Declaration shall not require the consent of the Association but shall require the signature of an officer of the Association acknowledging it. In addition, Declarant's prior written consent shall be necessary so long as Declarant owns any property described in Exhibits "A" or "B." Thereafter, each condominium unit within the condominium shall be treated in all respects as a Unit.

Section 10 Additional Rights Reserved to Declarant.

10.1 Withdrawal of Property.

Declarant reserves the right to amend this Declaration, so long as it has a right to annex additional property pursuant to Section 9.1, for the purpose of removing from the coverage of this Declaration any portion of Trailwoods which has not yet been improved with structures. Such amendment shall not require the consent of any Person other than the Owner(s) of the property to be withdrawn, if such Owner is not Declarant. If the property is Common Area, the Association shall consent to such withdrawal.

10.2 Marketing and Sales Activities.

Declarant and Builders authorized by Declarant may construct and maintain upon portions of the Common Area such facilities and activities as, in the sole opinion of Declarant, may be reasonably required, convenient, or incidental to the construction or sale of Units, including, but not limited to, business offices, signs, model units, and sales offices. Declarant and authorized Builders shall have a license with interest for access to and use of such facilities.

10.3 Right To Develop.

Declarant and its employees, agents and designees shall have a right of access and use and an easement over and upon all of the Common Area for the purpose of making, constructing and installing such improvements to the Common Area as it deems appropriate in its sole discretion.

Every Person that acquires any interest in Trailwoods acknowledges that Trailwoods is a planned community, the development of which is likely to extend over many years, and agrees not to use Association funds to protest, challenge or otherwise object to changes in uses or density of property outside the property in which such Person holds an interest. To be clear, no Association funds shall be used to challenge, protest, object to, or otherwise interfere with the Declarant's development activities in Trailwoods.

10.4 Right To Approve Changes in Standards.

No amendment to or modification of any Use Restrictions and Rules shall be effective without prior notice to and the written approval of Declarant so long as Declarant owns property subject to this Declaration or which may become subject to this Declaration in accordance with Section 9.1.

10.5 Right To Transfer or Assign Declarant Rights.

Any or all of the special rights and obligations of Declarant set forth in this Declaration or the By-Laws may be transferred in whole or in part to other Persons; provided, the transfer shall not reduce an obligation nor enlarge a right beyond that which Declarant has under this Declaration or the By-Laws. No such transfer or assignment shall be effective unless it is in a written instrument signed by Declarant and duly Recorded. The foregoing sentence shall not preclude Declarant from permitting other Persons to exercise, on a one time or limited basis, any right reserved to Declarant in this Declaration where Declarant does not intend to transfer such right in its entirety, and in such case it shall not be necessary to Record any written assignment

unless necessary to evidence Declarant's consent to such exercise.

10.6 Exclusive Rights To Use Name of Development.

No Person shall use the name "Trailwoods" or any derivative of such name in any printed, electronic, or promotional material without Declarant's prior written consent. However, Owners may use the name "Trailwoods" in printed or promotional matter where such term is used solely to specify that particular property is located at Trailwoods and the Association shall be entitled to use the word "Trailwoods" in its name.

10.7 Termination of Rights.

The rights contained in this Section shall not terminate until the earlier of (a) the date of termination of the Class B Control Period pursuant to Section 9.1 or (b) Recording by Declarant, in the sole discretion of the Declarant, of a written statement terminating such rights.

PART FIVE: PROPERTY RIGHTS WITHIN THE COMMUNITY

The nature of living in a planned community, with its wide array of properties and development types and ongoing development activity, requires the creation of special property rights and provisions to address the needs and responsibilities of the Owners, Declarant, the Association, and others in or adjacent to the community.

Section 11 Easements.

11.1 Easements in Common Area.

Declarant grants to each Owner a nonexclusive right and easement of use, access, and enjoyment in and to the Common Area, subject to:

- (1) Trailwoods Governing Documents and any other applicable covenants;
- (2) Any restrictions or limitations contained in any deed conveying such property to the Association;
- (3) The Board's right to:
 - (i) adopt rules regulating the use and enjoyment of the Common Area, including rules limiting the number of guests who may use the Common Area;
 - (ii) suspend the right of an Owner to use recreational facilities within the Common Area (A) for any period during which any charge against such Owner's Unit remains delinquent, and (B) for a period not to exceed 30 days for a single violation or for a longer period in the case of any continuing violation, of Trailwoods Governing Documents after notice and a hearing pursuant to Section 3.24 of the By-Laws;
 - (iii) dedicate or transfer all or any part of the Common Area, subject to such approval requirements as may be set forth in this Declaration;
 - (iv) impose reasonable membership requirements and charge reasonable admission or other use fees for the use of any recreational facility situated upon the Common Area;
 - (v) permit use of any recreational facilities situated on the Common Area by persons other than Owners, their families, lessees and guests upon payment of use fees established by the

Board;

(vi) mortgage, pledge, or hypothecate any or all of its real or personal property as security for money borrowed or debts incurred;

(vii) designate certain areas and facilities within the Common Area as open for the use and enjoyment of the public in accordance with Section 7.9.

Any Owner may extend the rights of use and enjoyment hereunder to the members of such Owner's family, lessees, and social invitees, as applicable, subject to reasonable regulation by the Board. An Owner who leases a Unit shall be deemed to have assigned all such rights to the lessee of such Unit for the period of the lease.

Each Owner shall have an express covenant and easement for light, air, sound, and view in and around the Common Areas. A framework for preserving such covenant and easement is provided by the standards outlined in the Design Review Guidelines, the Governing Documents, and the Trailwoods-Wide Standard. This covenant and easement seeks to preserve the tranquil, peaceful, and aesthetically pleasing enjoyment of Owners within the Common Area. This covenant and easement shall not purport to provide any Owner substantive rights in any Unit burdened by this easement, only that the Owners may expect the Design Review Board to interpret and enforce the Design Review Guidelines to encourage a natural, peaceful, and aesthetically pleasing Common Area enjoyment experience.

Declarant, so long as Declarant owns any property described in Exhibits "A" or "B," and the Association shall have the right to grant easements in and to the Common Area to any service provider or third-party contractor as may be necessary, in the sole discretion of Declarant or the Association, in connection with such service provider's or contractor's provision of services to Trailwoods. Any such easements shall be subject to any limitations or restrictions placed upon the easement by the grantor. The grantor of such easements, either Declarant or the Association, shall have the right to require specifically that the party exercising the easements, after exercising the easement, take restorative or ameliorative action with respect to the burdened property.

11.2 Easements of Encroachment.

Declarant grants reciprocal appurtenant easements of encroachment, and for maintenance and use of any permitted encroachment, between each Unit and any adjacent Common Area due to the unintentional placement or settling or shifting of the improvements constructed, reconstructed, or altered thereon (in accordance with the terms of these restrictions) to a distance of not more than three feet, as measured from any point on the common boundary along a line perpendicular to such boundary. However, in no event shall an easement for encroachment exist if such encroachment occurred due to willful and knowing conduct on the part of, or with the knowledge and consent of, the Person claiming the benefit of such easement.

11.3 Easements for Utilities, Etc.

(1) The property described in Exhibits "A" or "B" shall be subject to such easements as are set forth in any and all separate, duly Recorded instruments, including without limitation, any

and all applicable subdivision plats, maps of dedication, easements and easement agreements, subject to such terms, conditions, limitations, or restrictions as may be set forth in such separate instruments. Such easements may include (but shall not be required to include) easements for ingress and egress, private streets, public and private paths and trails, access for maintenance purposes, drainage and storm drains, landscape irrigation, private and public utilities, open space and visibility, emergency vehicle, and service vehicle access. Declarant and the Association, for themselves and their respective successors and assigns, each reserve the right to grant, convey, and dedicate over, upon, beneath, and across any land owned by it, any and all easements it may deem appropriate, whether in favor of any governmental entity, including Cleveland County and the City of Norman, any public or private utility company, or any other third party, on such terms and subject to such conditions, limitations, or restrictions as may be necessary or appropriate to carry out the purpose of such easement.

(2) Declarant also reserves for itself and grants to the Association the non-exclusive right and power to grant and Record such specific easements as may be necessary, in the sole discretion of Declarant or the Association, as applicable, in connection with the orderly development of any property described in Exhibits "A" and "B;" provided, the Association shall have such right and power only with respect to property that has been subjected to this Declaration in accordance with Section 9 and only with respect to property that is owned by Declarant or the Association, as applicable.

(3) All work associated with the exercise of the easements described in subsections (1) and (2) of this Section shall be performed in such a manner as to minimize interference with the use and enjoyment of the property burdened by the easement. The grantor of the easements described in subsection (1) or (2), either Declaration or the Association, shall have the right to require specifically that the party exercising the easement, after exercising the easement, take restorative or ameliorative action with respect to the burdened property. Upon completion of the work, the Person exercising the easement shall restore the property, to the extent reasonably possible, to its condition prior to the commencement of the work. The exercise of these easements shall not extend to permitting entry into the structures on any Unit, nor shall it unreasonably interfere with the use of any Unit and, except in an emergency, entry onto any Unit shall be made only after reasonable notice to the Owner or occupant.

11.4 Easements To Serve Additional Property.

Declarant hereby reserves for itself and its duly authorized agents, successors, assigns, and mortgagees, an easement over the Association Common Area for the purposes of enjoyment, use, access, and development of the property described in Exhibit "B," whether or not such property is made subject to this Declaration. This easement includes, but is not limited to, a right of ingress and egress over the Common Area for construction of roads and for connecting and installing utilities on such property.

Declarant agrees that it and its successors or assigns shall be responsible for any damage caused to the Common Area as a result of their actions in connection with development of such property. In the event of any such damage to the property, whether to natural conditions or structures and regardless of whether such damage is the result of negligent, willful, or any other

type of action, Declarant or its successors or assigns, whichever is appropriate, shall repair such property and shall restore it to the condition which existed prior to the occurrence of the damage or to the condition any governmental entity having jurisdiction requires, whichever standard is stricter. Declarant further agrees that if the easement is exercised for permanent access to such property and such property or any portion thereof benefiting from such easement is not made subject to this Declaration, Declarant, its successors or assigns shall enter into a reasonable agreement with the Association to share the cost of any maintenance which the Association provides to or along any roadway providing access to such property.

11.5 Easements for Maintenance, Emergency and Enforcement.

Declarant reserves to itself and grants to the Association easements over Trailwoods as necessary to enable the Association to fulfill its maintenance responsibilities under Section 7.2. The Association shall also have the right, but not the obligation, to enter upon any Unit for emergency, security, and safety reasons, to perform maintenance and to inspect for the purpose of ensuring compliance with and enforce Trailwoods Governing Documents; provided, however, except to avoid imminent threat of personal injury or property damage, entry into any portion of any property not generally open to the public shall only be authorized during reasonable hours and after receipt of the consent of the Owner or occupant, which consent shall not unreasonably be withheld.

11.6 Easements for Irrigation, Detention/Retention Maintenance, and Flood Water.

To the extent that any lakes, ponds, channels, detention ponds, retention areas, collections of storm water drainage (collectively, Detention/Retention Area) is located within the Common Area, this Declaration hereby creates, in favor of Declarant and its successors, assigns, and designees, the nonexclusive right and easement, but not the obligation, to enter upon any Detention/Retention Area located within the Common Area to (a) install, operate, maintain, and replace pumps to supply irrigation water to the Common Area; (b) construct, maintain, and repair structures and equipment used for retaining water; and (c) maintain such areas in a manner consistent with Trailwoods-Wide Standard.

To the extent that any Detention/Retention Area is located within the Common Area, this Declaration hereby creates in favor of the Association and its successors, assigns, and designees, the nonexclusive right and easement to enter upon any Detention/Retention Area located within the Common Area to (a) install, operate, maintain, and replace pumps to supply Detention/Retention Area to the Common Area; (b) construct, maintain, and repair structures and equipment used for retaining water; and (c) maintain such areas in a manner consistent with the Trailwoods-Wide Standard.

Declarant, the Association, and their successors, assigns and designees shall have an access easement over and across any of Trailwoods abutting or containing any Detention/Retention Area to the extent reasonably necessary to exercise their rights under this Section.

Declarant reserves for itself, the Association, and their successors, assigns and designees, a perpetual, nonexclusive right and easement of access and encroachment over the Common Area and Units (but not the dwellings thereon) adjacent to or within 100 feet of any Detention/Retention Area at Trailwoods, in order to (a) alter in any manner and generally maintain any irrigation lake within the Common Area; and (b) maintain and landscape the slopes and banks pertaining to such areas. All persons entitled to exercise these easements shall use reasonable care in and repair any damage resulting from the intentional exercise of such easements. Nothing herein shall be construed to make Declarant, the Association, or any other Person liable for damage or injury resulting from flooding or surface runoff due to rainfall or other natural occurrences.

11.7 Easements for Drainage Areas.

This Declaration hereby creates in favor of Declarant, so long as Declarant owns any property described in Exhibits "A" or "B," and the Association, and their successors, assigns, and designees, the nonexclusive right and easement to enter upon drainage ways, drainage culverts, natural drainage areas, washes and wash areas, other areas at Trailwoods, including areas within Units, used to drain surface runoff and flood waters, and any improvements and equipment installed or used in connection therewith (collectively, "Drainage Areas") to install, maintain, repair, and replace such areas and property. Except to avoid imminent threat of personal injury or property damage, entry onto any portion of any property not generally open to the public shall only be authorized during reasonable hours and after receipt of the Owner's or occupant's consent, which consent shall not unreasonably be withheld.

11.8 Easements for Screening and Fencing.

This Declaration hereby creates in favor of Declarant, so long as Declarant owns any property described in Exhibits "A" or "B," and the Association, and their successors, assigns, and designees, the nonexclusive right and easement to enter upon Units and other areas within Trailwoods, on which screening and fencing has been installed for the purpose of improving the aesthetic quality of the Property. Except to avoid imminent threat of personal injury or property damage, entry onto any portion of any property not generally open to the public shall only be authorized during reasonable hours and after receipt of the Owner's or occupant's consent, which consent shall not unreasonably be withheld.

PART SIX: RELATIONSHIPS WITHIN AND OUTSIDE THE COMMUNITY

The growth and success of Trailwoods as a community in which people enjoy living, working, and playing requires good faith efforts to resolve disputes amicably, attention to and understanding of relationships within the community and with its neighbors, and protection of the rights of others who have an interest in the community.

Section 12 Dispute Resolution and Limitation on Litigation.

12.1 Consensus for Association Litigation.

Except as provided in this Section, the Association shall not commence a judicial or

administrative proceeding without the approval at least two-thirds of the Members. This Section shall not apply, however, to (a) actions brought by the Association to enforce Trailwoods Governing Documents (including, without limitation, the foreclosure of liens); (b) the imposition and collection of assessments; (c) proceedings involving challenges to ad valorem taxation; or (d) counterclaims brought by the Association in proceedings instituted against it. This Section shall not be amended unless such amendment is approved by the percentage of votes, and pursuant to the same procedures necessary to institute proceedings as provided above.

Prior to the Association or any Member commencing any judicial or administrative proceeding to which Declarant is a party and which arises out of an alleged defect at Trailwoods or any improvement constructed upon Trailwoods, Declarant shall have the right to be heard by the Members, or the particular Member, and to access, inspect, correct the condition of, or redesign any portion of Trailwoods, including any improvement as to which a defect is alleged. In addition, the Association or the Member shall notify the builder who constructed the subject improvement prior to retaining any other expert as an expert witness or for other litigation purposes.

12.2 Dispute Resolution and Enforcement.

Subject to Section 12.1, prior to the Declarant, Association, or any Member bringing any judicial or administrative proceeding under the Governing Documents or for a claim against the Declarant, Association, or any Member, such Person making a claim shall make a good faith attempt to negotiate in person with the other party, including seeking formal pre-litigation mediation, for the resolution of the dispute. In the event good faith negotiations fail to resolve the dispute, the Person shall thereafter be entitled to sue in any court of competent jurisdiction or to initiate proceedings before any appropriate administrative tribunal on their claim. Each Party shall bear its own costs of any mediation, including attorneys' fees, and each Party shall share equally all charges rendered by any mediator. If the Parties agree to a resolution of any claim through negotiation or mediation and any Party thereafter fails to abide by the terms of such agreement, then any other Party may file suit or initiate administrative proceedings to enforce such agreement without the need to again comply with the procedures set forth above. In such event, the Party taking action to enforce the agreement shall be entitled to recover from the non-complying Party (or if more than one non-complying Party, from all such Parties pro rata) all costs incurred in enforcing such agreement, including, without limitation, attorneys' fees and court costs.

Each Owner shall comply strictly with the Governing Documents, including any rules, regulations, and resolutions of the Association. Failure to so comply shall be grounds for the taking of such actions elsewhere provided for in the Governing Documents, including but not limited to the institution of legal proceedings in an action at law and/or in equity. Should the Declarant or Association engage legal counsel for representation, all costs associated with such engagement, including litigation costs and expenses shall be recovered from the other party, which may be a Specific Assessment if the other party is a Member. No delay, failure, or omission on the part of the Declarant or Association in exercising any right, power, or remedy provided in these Governing Documents shall be construed as an acquiescence thereto or shall be deemed a waiver of the right to enforce such right, power, or remedy thereafter as to the same

violation or breach, and shall act as no bar to enforcement.

Section 13 Mortgagee Provisions.

The following provisions are for the benefit of holders, insurers and guarantors of first Mortgages on Units in the Properties. The provisions of this Section apply to both this Declaration and to the By-Laws, notwithstanding any other provisions contained therein.

13.1 Notices of Action.

An institutional holder, insurer, or guarantor of a first Mortgage which provides a written request to the Association (such request to state the name and address of such holder, insurer, or guarantor and the street address of the Unit to which its Mortgage relates, thereby becoming an "Eligible Holder"), will be entitled to timely written notice of:

- (1) Any condemnation loss or any casualty loss which affects a material portion of the Properties or which affects any Unit on which there is a first Mortgage held, insured, or guaranteed by such Eligible Holder;
- (2) Any delinquency in the payment of assessments or charges owed by a Unit subject to the Mortgage of such Eligible Holder, where such delinquency has continued for a period of 60 days, or any other violation of Trailwoods Governing Documents relating to such Unit or the Owner or Occupant which is not cured within 60 days;
- (3) Any lapse, cancellation, or material modification of any insurance policy maintained by the Association; or
- (4) Any proposed action which would require the consent of a specified percentage of Eligible Holders.

13.2 Special FHLMC Provision.

So long as required by the Federal Home Loan Mortgage Corporation, the following provisions apply in addition to and not in lieu of the foregoing Section. Unless at least 67% of the first Mortgagees or Members representing at least 67% of the total Association vote consent, the Association shall not:

- (1) By act or omission seek to abandon, partition, subdivide, encumber, sell, or transfer all or any portion of the real property comprising the Common Area which the Association owns, directly or indirectly (the granting of easements for utilities or other similar purposes consistent with the intended use of the Common Area shall not be deemed a transfer within the meaning of this subsection);
- (2) Change the method of determining the obligations, assessments, dues, or other charges which may be levied against an Owner of a Unit;

(3) By act or omission change, waive, or abandon any scheme of regulations or enforcement pertaining to architectural design, exterior appearance or maintenance of Units and the Common Area (the issuance and amendment of architectural standards, procedures, rules and regulations, or use restrictions shall not constitute a change, waiver, or abandonment within the meaning of this provision);

(4) Fail to maintain insurance, as required by this Declaration; or

(5) Use hazard insurance proceeds for any Common Area losses for other than the repair, replacement, or reconstruction of such property.

First Mortgagees may, jointly or singly, pay taxes or other charges which are in default and which may or have become a charge against the Common Area and may pay overdue premiums on casualty insurance policies or secure new casualty insurance coverage upon the lapse of an Association policy, and first Mortgagees making such payments shall be entitled to immediate reimbursement from the Association.

13.3 Other Provisions for First Lien Holders.

To the extent not inconsistent with Oklahoma law:

(1) Any restoration or repair of Trailwoods after a partial condemnation or damage due to an insurable hazard shall be performed substantially in accordance with this Declaration and the original plans and specifications unless the approval is obtained of the Eligible Holders of first Mortgages on Units to which more than 50% of the votes of Units subject to Mortgages held by such Eligible Holders are allocated.

(2) Any election to terminate the Association after substantial destruction or a substantial taking in condemnation shall require the approval of the Eligible Holders of first Mortgages on Units to which more than 50% of the votes of Units subject to Mortgages held by such Eligible Holders are allocated.

13.4 Amendments to Documents.

The following provisions do not apply to amendments to Trailwoods Governing Documents or to termination of the Association as a result of destruction, damage, or condemnation pursuant to Section 13.3(1) and (2), to the addition of land in accordance with Section 9, or to Declarant rights under Sections 10 and 17:

(1) The consent of Members representing at least 67% of the Class "A" votes and of Declarant, so long as it owns any land subject to this Declaration, and the approval of the Eligible Holders of first Mortgages on Units to which at least 67% of the votes of Units subject to a Mortgage appertain, shall be required to terminate the Association.

(2) The consent of Members representing at least 67% of the Class "A" votes and of Declarant, so long as it owns any land subject to this Declaration, and the approval of Eligible Holders of

first Mortgages on Units to which more than 50% of the votes of Units subject to a Mortgage appertain, shall be required materially to amend any provisions of the Declaration, By-Laws, or Articles of Incorporation, or to add any material provisions thereto which establish, provide for, govern, or regulate any of the following:

- (i) voting;
- (ii) assessments, assessment liens, or subordination of such liens;
- (iii) reserves for maintenance, repair, and replacement of the Common Area;
- (iv) insurance or fidelity bonds;
- (v) rights to use the Common Area;
- (vi) responsibility for maintenance and repair of Trailwoods;
- (vii) expansion or contraction of Trailwoods or the addition, annexation, or withdrawal of property to or from the Association;
- (viii) boundaries of any Unit;
- (ix) leasing of Units;
- (x) imposition of any right of first refusal or similar restriction of the right of any Owner to sell, transfer, or otherwise convey his or her Unit;
- (xi) establishment of self-management by the Association where professional management has been required by an Eligible Holder; or
- (xii) any provisions included in the Declaration, By-Laws, or Articles of Incorporation which are for the express benefit of holders, guarantors, or insurers of first Mortgages on Units.

13.5 No Priority.

No provision of this Declaration or the By-Laws gives or shall be construed as giving any Owner or other party priority over any rights of the first Mortgagee of any Unit in the case of distribution to such Owner of insurance proceeds or condemnation awards for losses to or a taking of the Common Area.

13.6 Notice to Association.

Upon request, each Owner shall be obligated to furnish to the Association the name and address of the holder of any Mortgage encumbering such Owner's Unit.

13.7 Failure of Mortgagee To Respond.

Any Mortgagee who receives a written request from the Board to respond to or consent to any action shall be deemed to have approved such action if the Association does not receive a written response from the Mortgagee within 30 days of the date of the Association's request, provided such request is delivered to the Mortgagee by certified or registered mail, return receipt requested.

13.8 Construction of Section 13.

Nothing contained in this Section shall be construed to reduce the percentage vote that must otherwise be obtained under the Declaration, By-Laws, or Oklahoma law for any of the acts

set out in this Section.

Section 14 Relationship with City of Norman, Cleveland County, and Media.

The Association shall promulgate and implement a process for and shall appoint a Person who serves as a single point of contact for the City of Norman, Cleveland County, media, and members of the public. The responsibilities of such Person shall include, without limitation, communicating with the City of Norman regarding maintenance issues within the purview of the Association and answering questions relevant to any matters for which the Association has responsibility or authority.

PART SEVEN: CHANGES IN THE COMMUNITY

Communities such as Trailwoods are dynamic and constantly evolving as circumstances, technology, needs and desires, and laws change, as the residents age and change over time, and as the surrounding community changes. Trailwoods and Trailwoods Governing Documents must be able to adapt to these changes while protecting the special features of Trailwoods that make Trailwoods unique.

Section 15 Changes in Ownership of Units.

Any Owner desiring to sell or otherwise transfer title to a Unit shall give the Board at least 14 days' prior written notice of the name and address of the purchaser or transferee, the date of such transfer of title, and such other information as the Board may reasonably require. The transferor shall continue to be jointly and severally responsible with the transferee for all obligations of the Owner of the Unit, including assessment obligations, until the date upon which such notice is received by the Board or the date title transfers, whichever is later.

Section 16 Changes in Common Area.

16.1 Condemnation.

If any part of the Common Area shall be taken (or conveyed in lieu of and under threat of condemnation by the Board acting on the written direction of Members representing at least 67% of the total Class "A" votes in the Association and of Declarant, as long as Declarant owns any property subject to the Declaration or which may be made subject to the Declaration in accordance with Section 9.1) by any authority having the power of condemnation or eminent domain, each Owner shall be entitled to written notice of such taking or conveyance prior to disbursement of any condemnation award or proceeds from such conveyance. Such award or proceeds shall be payable to the Association to be disbursed as set forth in this Section.

If the taking or conveyance involves a portion of the Common Area on which improvements have been constructed, the Association shall restore or replace such improvements on the remaining land included in the Common Area to the extent available, unless within 60 days after such taking, Declarant, so long as Declarant owns any property subject to the Declaration or which may be made subject to the Declaration in accordance with Section 9.1,

and Members representing at least 75% of the total Class "A" vote of the Association shall otherwise agree. Any such construction shall be in accordance with plans approved by the Board. The provisions of Section 7.3.3 regarding funds for restoring improvements shall apply.

If the taking or conveyance does not involve any improvements on the Common Area, or if a decision is made not to repair or restore, or if net funds remain after any such restoration or replacement is complete, then such award or net funds shall be disbursed to the Association and used for such purposes as the Board shall determine.

16.2 Partition.

Except as permitted in this Declaration, the Common Area shall remain undivided, and no Person shall bring any action for partition of any portion of the Common Area without the written consent of all Owners and Mortgagees. This Section shall not prohibit the Board from acquiring and disposing of tangible personal property nor from acquiring and disposing of real property which may or may not be subject to this Declaration.

16.3 Transfer or Dedication of Common Area.

The Association may dedicate portions of the Common Area to Cleveland County, Oklahoma, the City of Norman, or to any other local, state, or federal governmental or quasi-governmental entity, subject to prior approval of the Declarant during the Class "B" Control Period.

Section 17 Amendment of Declaration.

17.1 By Declarant.

In addition to specific amendment rights granted elsewhere in this Declaration and without restriction by any term within this Declaration, until termination of the Class "B" membership, Declarant may unilaterally amend this Declaration for any purpose and at any time, including during restrictive periods. Thereafter, Declarant may unilaterally amend this Declaration if such amendment is necessary (i) to bring any provision into compliance with any applicable governmental statute, rule, regulation, or judicial determination; (ii) to enable any reputable title insurance company to issue title insurance coverage on the Units; (iii) to enable any institutional or governmental lender, purchaser, insurer or guarantor of mortgage loans, including, for example, the Federal National Mortgage Association or Federal Home Loan Mortgage Corporation, to make, purchase, insure or guarantee mortgage loans on the Units; or (iv) to satisfy the requirements of any local, state or federal governmental agency.

17.2 By Members.

Except as otherwise specifically provided above and elsewhere in this Declaration, this Declaration may be amended only by the affirmative vote or written consent, or any combination thereof, of Members representing 75% of the total Class "A" votes in the Association, including 75% of the Class "A" votes held by Members other than Declarant, and the consent of Declarant, so long as Declarant owns any property subject to this Declaration or which may become subject

to this Declaration in accordance with Section 9.1. In addition, the approval requirements set forth in Section 13 shall be met, if applicable.

Notwithstanding the above, the percentage of votes necessary to amend a specific clause shall not be less than the prescribed percentage of affirmative votes required for action to be taken under that clause.

17.3 Validity and Effective Date.

No amendment may remove, revoke, or modify any right or privilege of Declarant or the Class "B" Member without the written consent of Declarant or the Class "B" Member, respectively (or the assignee of such right or privilege).

If an Owner consents to any amendment to this Declaration or the By-Laws, it will be conclusively presumed that such Owner has the authority to consent, and no contrary provision in any Mortgage or contract between the Owner and a third party will affect the validity of such amendment.

Any amendment shall become effective upon Recording, unless a later effective date is specified in the amendment. Any procedural challenge to an amendment must be made within six months of its Recordation or such amendment shall be presumed to have been validly adopted. In no event shall a change of conditions or circumstances operate to amend any provisions of this Declaration.

17.4 Exhibits.

The Exhibits "A," "B," and "E" attached to this Declaration are incorporated by this reference and amendment of such exhibits shall be governed by this Section. All other exhibits are attached for informational purposes (not to minimize their enforceability) and may be amended as provided therein or in the provisions of this Declaration which refer to such exhibits.

IN WITNESS WHEREOF, the undersigned Declarant has executed the Trailwood Declaration and attached Exhibits the date and year first written above on the signature blocks below.

TERRA VERDE, L.L.C., - DECLARANT

An Oklahoma limited liability company

By: 
Richard McKown, the Managing Member

ACKNOWLEDGEMENT

State of Oklahoma }
 } ss
County of Cleveland }

Before me, the undersigned Notary Public in and for the above county and state, on the date of October 4, 2005, personally appeared Richard McKown, known to me to be the identical person who executed his name to the foregoing Declaration, who is the duly authorized agent for the Declarant for executed such Declaration, who acknowledged to me that he did so as his free and voluntary act on behalf of the Declarant for the uses and purposes set forth in the Declaration.

Subscribed and sworn to before me
The date next written above.
My commission expires:

Notary Public: *Sherry R. Neldhart*

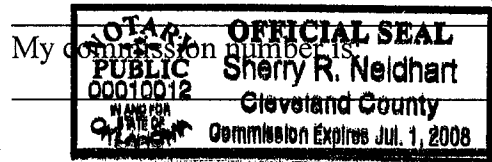

EXHIBIT "A"

LEGAL DESCRIPTION

TRAILWOODS ADDITION P.U.D. NORMAN, OKLAHOMA

**SEPTEMBER 14, 2004
Revised : September 27, 2005**

Being a part of the Southwest Quarter (SW/4) of Section 18, Township 9 North (T9N), Range 2 West (R2W), Norman, Cleveland County, Oklahoma, and being more particularly described as the following two separate tracts of land:

TRACT 1

COMMENCING at the S.E. corner of said SW/4 of Section 18; THENCE North 89°46'48" West along the South line of said SW/4 a distance of 450.00 feet to the POINT OF BEGINNING.

THENCE continuing North 89°46'48" West along said South line a distance of 775.14 feet; THENCE North 00°13'12" East a distance of 50.00 feet to a point on the North 50.00 foot right-of-way line of Rock Creek Road; THENCE North 45°13'12" East a distance of 35.36 feet; THENCE North 00°13'12" East a distance of 55.80 feet to a point of curvature; THENCE around a curve to the left having a radius of 290.00 feet (said curve subtended by a chord which bears North 22°04'15" West a distance of 220.00 feet) with an arc length of 225.65 feet to a point of reverse curvature; THENCE around a curve to the right having a radius of 332.14 feet (said curve subtended by a chord which bears North 13°50'47" West a distance of 337.30 feet) with an arc length of 353.78 feet to a point of reverse curvature; THENCE around a curve to the left having a radius of 160.00 feet (said curve subtended by a chord which bears North 20°43'15" East a distance of 22.61 feet) with an arc length of 22.63 feet) THENCE North 04°02'35" West a distance of 41.79 feet to a point on a curve; THENCE around a curve to the right having a radius of 280.00 feet (said curve subtended by a chord which bears North 32°39'37" West a distance of 20.73 feet) with an arc length of 20.73 feet; THENCE North 68°28'58" West a distance of 38.02 feet; THENCE North 20°27'24" West a distance of 50.02 feet; THENCE North 27°54'42" East a distance of 36.51 feet to a point on a curve; THENCE around a curve to the right having a radius of 566.51 feet (said curve subtended by a chord which bears North 00°01'26" East a distance of 273.16 feet) with an arc length of 275.88 feet to a point of reverse curvature; THENCE around a curve to the left having a radius of 947.63 feet (said curve subtended by a chord which bears North 08°38'20" East a distance of 176.51 feet) with an arc length of 176.25 feet;

THENCE North 45°14'46" West a distance of 33.59 feet; THENCE North 05°56'34" East a distance of 50.62 feet; THENCE North 42°22'07" East a distance of 35.74 feet; THENCE North 83°11'37" East a distance of 50.12 feet; THENCE South 51°30'47" East a distance of 32.63 feet to a point on a curve; THENCE around a curve to the left having a radius of 540.85 feet (said curve subtended by a chord which bears North 72°47'43" East a distance of 96.12 feet) with an arc length of 96.25 feet to a point of reverse curvature; THENCE around a curve to the right having a radius of 350.00 feet (said curve subtended by a chord which bears North 67°58'16" East a distance of 3.35 feet) with an arc length of 3.35 feet; THENCE North 29°42'01" East a distance of 37.97 feet; THENCE North 76°27'17" East a distance of 50.33 feet; THENCE South 53°46'27" East a distance of 36.18 feet to a point on a curve; THENCE around a curve to the right having a radius of 350.00 feet (said curve subtended by a chord which bears South 79°58'50" East a distance of 185.84 feet) with an arc length of 188.09 feet to a point of reverse curvature; THENCE around a curve to the left having a radius of 365.18 feet (said curve subtended by a chord which bears South 80°43'48" East a distance of 203.09 feet) with an arc length of 205.80 feet; THENCE North 83°07'31" East a distance of 11.85 feet; THENCE North 42°39'40" East a distance of 38.04 feet; THENCE South 83°24'35" East a distance of 50.01 feet to a point on a curve; THENCE around a curve to the left having a radius of 18.00 feet (said curve subtended by a chord which bears South 16°35'19" East a distance of 13.27 feet) with an arc length of 13.59 feet to a point of reverse curvature; THENCE around a curve to the right having a radius of 48.00 feet (said curve subtended by a chord which bears South 07°23'58" East a distance of 49.18 feet) with an arc length of 51.63 feet to a point of reverse curvature; THENCE around a curve to the left having a radius of 18.00 feet (said curve subtended by a chord which bears South 01°47'10" West a distance of 13.27 feet) with an arc length of 13.59 feet to a point of continuing curvature; THENCE around a curve to the left having a radius of 175.00 feet (said curve subtended by a chord which bears South 54°48'27" East a distance of 200.61 feet) with an arc length of 213.64 feet; THENCE South 89°46'48" East a distance of 55.07 feet; THENCE North 45°04'44" East a distance of 35.27 feet; THENCE South 89°46'48" East a distance of 50.00 feet; THENCE South 44°55'16" East a distance of 35.44 feet; THENCE South 89°46'48" East a distance of 130.00 feet; THENCE North 45°04'44" East a distance of 35.27 feet; THENCE South 89°46'48" East a distance of 50.00 feet; THENCE South 44°55'16" East a distance of 35.44 feet to a point on a curve; THENCE around a curve to the left having a radius of 100.00 feet (said curve subtended by a chord which bears North 81°20'59" East a distance of 30.79 feet) with an arc length of 30.91 feet to a point of reverse curvature; THENCE around a curve to the right having a radius of 150.00 feet (said curve subtended by a chord which bears North 81°08'09" East a distance of 45.08 feet) with an arc length of 45.25 feet to a point on the West property line of Poppy Grove Addition Section 2 (as filed in Book 19 Page 182); THENCE South 00°03'45" East along said West property line a distance of 153.87 feet; THENCE North 89°46'48" West a distance of 450.00 feet; THENCE South 00°03'45" East a distance of 1051.13 feet to the POINT OF BEGINNING. Said tract contains 29.47 acres more or less.

TRACT 2

COMMENCING at the S.E. corner of said SW/4 of Section 18; THENCE North 89°46'48" West along the South line of said SW/4 a distance of 450.00 feet; THENCE North 00°03'45" West a distance of 1051.13 feet; THENCE South 89°46'48" East a distance of 450.00 feet; THENCE North 00°03'45" West a distance of 153.87 feet to a point on a curve; THENCE around a curve to the left having a radius of 150.00 feet (said curve subtended by a chord which bears South 81°08'09" West a distance of 45.08 feet) and an arc distance of 45.25 feet to a point of reverse curvature; THENCE around a curve to the right having a radius of 100.00 feet (said curve subtended by a chord which bears South 81°20'59" West a distance of 30.79 feet) and an arc distance of 30.91 feet; THENCE North 44°55'16" West a distance of 35.44 feet; THENCE North 89°46'48" West a distance of 50.00 feet; THENCE South 45°04'44" West a distance of 35.27 feet; THENCE North 89°46'48" West a distance of 130.00 feet; THENCE North 44°55'16" West a distance of 35.44 feet; THENCE North 89°46'48" West a distance of 50.00 feet; THENCE South 45°04'44" West a distance of 35.27 feet; THENCE North 89°46'48" West a distance of 55.07 feet to a point of curvature; THENCE around a curve to the right having a radius of 175.00 feet (said curve subtended by a chord which bears North 88°09'04" West a distance of 9.95 feet) and an arc distance of 9.95 feet to the POINT OF BEGINNING.

Thence continuing around a curve to the right having a radius of 175.00 feet (said curve subtended by a chord which bears North 53°10'43" West a distance of 192.38 feet) and an arc distance of 203.68 feet; THENCE North 86°27'22" East a distance of 92.53 feet; THENCE North 05°54'55" East a distance of 147.40 feet; THENCE North 08°11'02" East a distance of 334.93 feet to a point on a curve; THENCE around a curve to the left having a radius of 350.00 feet (said curve subtended by a chord which bears North 60°37'37" East a distance of 145.35 feet) and an arc distance of 146.41 feet; THENCE South 70°21'47" East a distance of 79.74 feet; THENCE North 88°05'07" East a distance of 119.76 feet; THENCE North 62°25'43" East a distance of 165.30 feet; THENCE South 00°03'45" East a distance of 314.85 feet; THENCE South 69°27'50" West a distance of 24.32 feet; THENCE North 27°46'36" West a distance of 105.21 feet; THENCE North 64°20'35" West a distance of 151.98 feet; THENCE South 79°05'26" West a distance of 151.98 feet; THENCE South 42°46'14" West a distance of 105.03 feet; THENCE South 27°19'12" West a distance of 74.05 feet; THENCE South 08°11'02" West a distance of 46.17 feet; THENCE South 00°03'39" East a distance of 342.31 feet to the POINT OF BEGINNING. Containing 2.29 acres, more or less.

Combining TRACT 1 with TRACT 2 gives a total area of 31.76 acres, more or less.

EXHIBIT "B"

Land Subject to Annexation

THE LANDS BEING WITHIN A TEN MILE RADIUS FROM THE PROPERTY DESCRIBED IN EXHIBIT "A."

EXHIBIT "C"

Initial Use Restrictions and Rules for Trailwoods

The following restrictions shall apply to all of Trailwoods until such time as they are amended, modified, repealed or limited by rules of the Association adopted pursuant to Section 3 of the Declaration.

1. General. Trailwoods shall be used only for residential and related purposes (which may include, without limitation, an information center and/or a sales office for any real estate broker retained by Declarant to assist in the sale of property described in Exhibits "A" or "B," offices for any property manager retained by the Association, or business offices for Declarant or the Association) consistent with this Declaration and any Supplemental Declaration.

2. Restrictions. The following activities are prohibited at Trailwoods unless expressly authorized by, and then subject to such conditions as may be imposed by, the Board:

2.1 Parking. Parking any vehicles on public or private streets or thoroughfares, or parking of commercial vehicles or equipment, mobile homes, recreational vehicles, golf carts, boats and other watercraft, trailers, stored vehicles, or inoperable vehicles in places other than enclosed garages; provided, construction, service and delivery vehicles shall be exempt from this provision for such period of time as is reasonably necessary to provide service or to make a delivery to a Unit or the Common Area;

2.2 Pets. Raising, breeding, or keeping animals, livestock, or poultry of any kind, except that a reasonable number of dogs, cats, or other usual and common household pets may be permitted in a Unit. However, those pets which are permitted to roam free, or, in the sole discretion of the Board, make objectionable noise, endanger the health or safety of, or constitute a nuisance or inconvenience to the occupants of other Units shall be removed upon the Board's request. If the pet owner fails to honor such request, the Board may remove the pet. Dogs shall be kept on a leash or otherwise confined in a manner acceptable to the Board whenever outside the dwelling. Pets shall be registered, licensed and inoculated as required by law;

2.3 Noxious, Offensive Activity. Any activity which emits foul or obnoxious odors outside the Unit or creates noise or other conditions which tend to disturb the peace or threaten the safety of the occupants of other Units;

2.4 Violations of Law. Any activity that violates local, state, or federal laws or regulations; however, the Board shall have no obligation to take enforcement action in the event of a violation;

2.5 Healthy Environment. Pursuit of hobbies or other activities that tend to cause an unclean, unhealthy, or untidy condition to exist outside of enclosed structures on the Unit;

2.6 Common Area Uses. Any noxious or offensive activity which in the reasonable

determination of the Board tends to cause embarrassment, discomfort, annoyance, or nuisance to persons using the Common Area or to the occupants of other Units;

2.7 Burning. Outside burning of trash, leaves, debris, or other materials;

2.8 Audible Discharge. Use or discharge of any radio, loudspeaker, horn, whistle, bell, or other sound device so as to be audible to occupants of other Units, except alarm devices used exclusively for security purposes;

2.9 Firecrackers, Firearms and Explosives. Use and discharge of firecrackers and other fireworks, firearms, and other explosives, provided, the Board shall have no obligation to take action to prevent or stop such discharge;

2.10 Dumping. Dumping grass clippings, leaves or other debris, petroleum products, fertilizers, or other potentially hazardous or toxic substances on any Unit or Common Area and in any drainage ditch, stream, pond, or lake, or elsewhere within Trailwoods, except that fertilizers may be applied to landscaping on Units provided care is taken to minimize runoff, and Declarant may dump and bury rocks and similar materials;

2.11 Accumulation of Debris. Accumulation of rubbish, trash, or garbage except between regular garbage pick ups, and then only in approved containers;

2.12 Obstructions. Obstruction or rechanneling drainage flows after location and installation of drainage swales, storm sewers, or storm drains, except that Declarant and the Association shall have such right; provided, the exercise of such right shall not materially diminish the value of or unreasonably interfere with the use of any Unit without the Owner's consent;

2.13 Subdivision of Units. Subdivision of a Unit into two or more Units, or changing the boundary lines of any Unit after a subdivision plat including such Unit has been approved and Recorded, except that Declarant shall be permitted to subdivide or replat Units which it owns;

2.14 Use of Water Areas. Swimming, boating, use of personal flotation devices, or other active use of lakes, ponds, streams, or other bodies of water within Trailwoods, except that catch and release fishing from the shore shall be permitted with appropriate licenses and Declarant, its successors and assigns, shall be permitted and shall have the exclusive right and easement to retrieve materials and objects from bodies of water within the Common Areas and to draw water from lakes, ponds, and streams within Trailwoods for purposes of irrigation and such other purposes as Declarant shall deem desirable. The Association shall not be responsible for any loss, damage, or injury to any person or property arising out of the authorized or unauthorized use of rivers, lakes, ponds, streams or other bodies of water within or adjacent to Trailwoods;

2.15 Investment Uses. Use of any Unit for operation of a timesharing, fraction-sharing, or similar program whereby the right to exclusive use of the Unit rotates among participants in the program on a fixed or floating time schedule over a period of years, except that Declarant and its assigns may operate such a program with respect to Units which it owns;

2.16 Combustible Materials. On-site storage of gasoline, heating, or other fuels, except that a reasonable amount of fuel may be stored on each Unit for emergency purposes and operation of lawn mowers and similar tools or equipment, and the Association shall be permitted to store fuel for operation of maintenance vehicles, generators, and similar equipment. This provision shall not apply to any underground fuel tank authorized pursuant to Section 4;

2.17 Business Uses. Any business, trade, or similar activity, except that an Owner or occupant residing in a Unit may conduct business activities within the Unit so long as: (i) the existence or operation of the business activity is not apparent or detectable by sight, sound, or smell from outside the Unit; (ii) the business activity conforms to all zoning requirements for Trailwoods; (iii) the business activity does not involve door-to-door solicitation of residents of Trailwoods or constitutes a day care facility; (iv) the business activity does not, in the Board's reasonable judgment, generate a level of vehicular or pedestrian traffic or a number of vehicles being parked in Trailwoods which is noticeably greater than that which is typical of Units in which no business activity is being conducted; and (v) the business activity is consistent with the residential character of Trailwoods and does not constitute a nuisance, or a hazardous or offensive use, or threaten the security or safety of other residents of Trailwoods, as may be determined in the Board's sole discretion.

The terms "business" and "trade," as used in this provision, shall be construed to have their ordinary, generally accepted meanings and shall include, without limitation, any occupation, work, or activity undertaken on an ongoing basis which involves the provision of goods or services to persons other than the provider's family and for which the provider receives a fee, compensation, or other form of consideration, regardless of whether: (i) such activity is engaged in full or part-time; (ii) such activity is intended to or does generate a profit; or (iii) a license is required.

Leasing of a Unit shall not be considered a business or trade within the meaning of this subsection. This subsection shall not apply to any activity conducted by Declarant or a Builder approved by Declarant with respect to its development and sale of Trailwoods or its use of any Units which it owns within Trailwoods, including the operation of a timeshare or similar program;

2.18 Wildlife. Capturing, trapping, or killing of wildlife within Trailwoods, except in circumstances posing an imminent threat to the safety of persons using Trailwoods;

2.19 Preservation of Natural Resources. Any activities which materially disturb or destroy the vegetation, wildlife, wetlands, or air quality within Trailwoods or which use excessive amounts of water or which result in unreasonable levels of sound or light pollution;

2.20 Vehicle Storage Conversions. Conversion of any vehicle storage structure to finished space for use as an apartment or other integral part of the living area on any Unit;

2.21 Operation of Motorized Vehicles. Operation of motorized vehicles, including but not limited to motorcycles, scooters, mopeds, go-carts, and golf carts, on sidewalks, pathways or

trails, except that motorized carts may be operated by those requiring the same for medical purposes; and

2.22 Construction Activities. Any construction, erection, placement, or modification of any thing, permanently or temporarily, on the outside portions of the Unit, whether such portion is improved or unimproved, except in strict compliance with the provisions of Section 4 of the Declaration. This shall include, without limitation, signs, basketball hoops, swing sets and similar sports and play equipment; clotheslines; garbage cans; woodpiles; above-ground swimming pools; docks, piers and similar structures; and hedges, walls, dog runs, animal pens, or fences of any kind; satellite dishes and antennas, except that:

2.22.1 an antenna designed to receive direct broadcast satellite services, including direct-to-home satellite services, that is one meter or less in diameter;

2.22.2 an antenna designed to receive video programming services via multipoint distribution services, including multichannel multipoint distribution services, instructional television fixed services, and local multipoint distribution services, that is one meter or less in diameter or diagonal measurement; or

2.22.3 an antenna that is designed to receive television broadcast signals;

(collectively, "Permitted Antennas") shall be permitted on Units, subject to such reasonable requirements as to location and screening as may be set forth in the Design Review Guidelines, consistent with applicable law, in order to minimize obtrusiveness as viewed from streets and adjacent property. Declarant and/or the Association shall have the right, without obligation, to erect an aerial, satellite dish, or other apparatus for a master antenna, cable, or other communication system for the benefit of all or a portion of Trailwoods, should any master system or systems be utilized by the Association and require such exterior apparatus.

3. Prohibited Conditions. The following shall be prohibited at Trailwoods:

3.1 Plants, animals, devices, or other things of any sort whose activities or existence in any way is noxious, dangerous, unsightly, unpleasant, or of a nature as may diminish or destroy the enjoyment of Trailwoods;

3.2 Structures, equipment, or other items on the exterior portions of a Unit which have become rusty, dilapidated, or otherwise fallen into disrepair; and

3.3 Sprinkler or irrigation systems or wells of any type which draw upon water from lakes, creeks, streams, rivers, ponds, wetlands, canals, or other ground or surface waters within Trailwoods, except that Declarant and the Association shall have the right to draw water from such sources.

3.4 Outbuildings, Temporary Structures. No temporary sheds, outbuildings, or temporary accessory buildings are allowed. Any sheds, outbuildings, or accessory buildings of a permanent nature must obtain DRB approval prior to installation pursuant to Section 4 of the Declaration.

4. Leasing of Units. "Leasing, leased, and lease" for purposes of this Paragraph, is defined as regular, exclusive occupancy of a Unit by any person, other than the Owner for which the Owner receives any consideration or benefit, including, but not limited to, a fee, service, gratuity, or emolument. "Owner Occupied Units" are defined for purposes of this Paragraph as Units occupied solely by the Owner, the members of the family of the Owner or other guests and invitees of the Owner who occupy without the payment of rent, as the occupant's principal residence or second home. This Paragraph expressly limits and controls Section 3.4(5) of the Declaration.

4.1 Leasing Restricted. Within the Properties, Units may be leased, provided the total percentage of leased Units within the Properties shall not exceed ten percent (10%) of the total number of Units within the Properties. Upon the occurrence of a decrease below 10% of Owner Occupied Units within the Properties, Units will be permitted to be leased on a first bona fide request, first permitted basis, until the number of units which are leased reaches 10%, at which time no further Units shall be leased until the number of leased Units drops below 10%.

Except for the Declarant, if a single entity (the same individual, investor group, partnership, or corporation) owns more than 5% of the total Units, no Unit in excess of 5% of the total Units within the Properties which it (a) owns and occupies as their residence and (b) leases, may be leased.

In order to administer the above regulation, all Persons who intend to purchase a Unit within the Properties shall file a certification either (a) that the Unit will not be occupied as the purchaser's principle residence or second home, or (b) covenanting and agreeing with the Association that the purchaser will occupy the Unit as an Owner Occupied Unit until the leasing restriction under this Rule is lifted.

The Association will keep a record of the Owner Occupied Units and leased Units. Each lease shall be for a term of no less than 12 months and each lessee shall expressly agree to the terms of the Governing Documents.

4.2 Professional Management of Leased Units.

4.2.1 Definitions. For purposes of this section:

a) "**Professional Manager**" shall mean a person or entity that Professionally Manages residential real estate within the United States and has the following qualifications:

- (1) If an individual, is a licensed real estate broker within the State of Oklahoma, and has been so licensed for a period of no less than three (3) years from the date such person seeks to manage a Leased Lot/Unit within the Addition;
- (2) If an entity, the controlling interest in such entity is owned by at least one person who is a licensed real estate broker within the State of Oklahoma, and has been so licensed for a period of no less than three (3) years from the date such entity seeks to manage a Leased Lot/Unit within the Addition;
- (3) Currently and continually Professionally Manages no less than five residential real estate properties within the State of Oklahoma;

- (4) Has Professionally Managed residential real estate no less than three (3) years prior to the date the Professional Manager seeks to manage a Leased Lot/Unit.
- b) “**Professionally Manage**” shall mean the administration, oversight, management or control of residential real estate by a Professional Manager.
- c) “**Leased Lot/Unit**” shall mean any Lot/Unit within the Addition not occupied by the Lot/Unit Owner and for which any remuneration is paid to the Owner for the use or occupancy of such Lot/Unit.

4.2.2 Leased Lot/Unit Restrictions and Requirements.

4.2.2.1 Professional Management. Each Leased Lot/Unit shall be Professionally Managed.

4.2.2.2 Registration. Prior to the date any Lot/Unit shall become a Leased Lot/Unit, each Professional Manager shall register the following with the Association:

- a. Name, business address, telephone and facsimile numbers, and email address for the individual Professional Manager;
- b. Professional Manager entity name, state of organizations, and date formed, business address, telephone and facsimile numbers, and email address for the entity Professional Manager;
- c. Date began property management of residential real estate;
- d. Maximum/minimum number of leased residential properties managed within the past 12 months;
- e. Five representative property address references and contacts;
- f. Photocopies of all residential real estate licenses held by the owners, employees, and agents of Manager, including: license issuing agency, date license was obtained, and a certification by the license holder that such license is current and in effect as of the date such license holder seeks to become qualified as a Professional Manager;
- g. Demonstrate compliance with all licensing, ordinances, and code for any structure located on the Leased Lot/Unit;
- h. Demonstrate adequate insurance coverage, including but not limited to 1) liability and casualty on each structure located on the Leased Lot/Unit, and 2) worker’s compensation on the Professional Manager.

4.2.2.3 Familiarity with Governing Documents. Each Professional Manager, their staff, employees, and agents shall demonstrate a familiarity with the Governing Documents to the Addition and shall agree to review the same with each tenant, lessee, or occupant.

4.2.3 Community-Wide Standard. Each Professional Manager and Leased Lot/Unit Owner shall acknowledge the existence of the Community Wide Standard within the Addition and shall expressly agree that the Leased Lot/Unit shall be maintained within such standard, each personally agreeing to bear any expense incurred by the Declarant and Association in bringing the Leased Lot/Unit into compliance with the Governing Documents and Community Wide Standard.

4.2.4 No Joint Venture or Partnership. The Owner of any Leased Lot/Unit and Professional Manager shall not be considered any partner, employee, agent or joint venturer with the Declarant or Association and no term within this Amendment shall create any implication or presumption of such relationship. No Owner of a Leased

Lot/Unit or Professional Manager shall hold themselves or any other out to be any partner, employee, agent or joint venturer with the Declarant or Association.

4.2.5 Leased Lot/Unit Sign Restrictions. Each Professional Manager shall comply with any applicable sign restriction contained within the Design Review Guidelines to the Addition.

EXHIBIT "D"

BYLAWS OF TRAILWOODS PROPERTY OWNERS ASSOCIATION, INC.

-TABLE OF CONTENTS-

ARTICLE

1. NAME, PRINCIPAL OFFICE, AND DEFINITIONS

- 1.1 Name
- 1.2 Principal Office
- 1.3 Definitions

2. ASSOCIATION: MEMBERSHIP, MEETINGS, QUORUM, VOTING, PROXIES

- 2.1 Membership
- 2.2 Place of Meetings
- 2.3 Annual Meetings
- 2.4 Special Meetings
- 2.5 Notice of Meetings
- 2.6 Waiver of Notice
- 2.7 Adjournment of Meetings
- 2.8 Voting
- 2.9 Proxies
- 2.10 Majority
- 2.11 Quorum
- 2.12 Conduct of Meetings
- 2.13 Action Without a Meeting

3. BOARD OF DIRECTORS: NUMBER, POWERS, MEETINGS

- A. Composition and Selection
 - 3.1 Governing Body; Composition
 - 3.2 Number of Directors
 - 3.3 Directors During Class 'B' Control Period
 - 3.4 Nomination and Election Procedures
 - 3.5 Election and Term of Office
 - 3.6 Removal of Directors and Vacancies
- B. Meetings
 - 3.7 Organizational Meetings
 - 3.8 Regular Meetings
 - 3.9 Special Meetings
 - 3.10 Waiver of Notice
 - 3.11 Telephonic Participation in Meetings
 - 3.12 Quorum of Board
 - 3.13 Compensation
 - 3.14 Conduct of Meetings

- 3.15 Notice to Owners; Open Meetings
- 3.16 Action Without a Formal Meeting
- C. Powers and Duties
 - 3.17 Powers
 - 3.18 Duties
 - 3.19 Right of Class 'B' Member to Disapprove Actions
 - 3.20 Management
 - 3.21 Accounts and Reports
 - 3.22 Borrowing
 - 3.23 Right to Contract
 - 3.24 Enforcement

4. OFFICERS

- 4.1 Officers
- 4.2 Election and Term of Office
- 4.3 Removal and Vacancies
- 4.4 Powers and Duties
- 4.5 Resignation
- 4.6 Agreements, Contracts, Deeds, Leases, Checks, Etc.
- 4.7 Compensation

5. COMMITTEES

- 5.1 General
- 5.2 Covenants Committee

6. MISCELLANEOUS

- 6.1 Fiscal Year
- 6.2 Parliamentary Rules
- 6.3 Conflicts
- 6.4 Books and Records
- 6.5 Notices
- 6.6 Amendment

BYLAWS OF TRAILWOODS ASSOCIATION, INC.

Article 1 Name, Principal Office, and Definitions

1.1 Name. The name of the corporation is Trailwoods Property Owners Association, Inc. (the "Association").

1.2 Principal Office. The principal office of the Association shall be located at 2400 Sharpish Road, at the Trailwoods in Norman, Oklahoma. The Association may have such other offices, either within or outside the State of Oklahoma, as the Board of Directors may determine or as the affairs of the Association may require.

1.3 Definitions. The words used in these Bylaws shall be given their normal, commonly understood definitions. Capitalized terms shall have the same meaning as set forth in that certain Recorded Declaration of Covenants, Conditions, and Restrictions for Trailwoods as it may be amended (the "Declaration"), unless the context indicates otherwise.

Article 2 Association Membership, Meetings, Quorum, Voting, Proxies

2.1 Membership. The Association shall have two classes of membership, Class "A" and Class "B," as more fully set forth in the Declaration and incorporated herein by this reference.

2.2 Place of Meetings. Meetings of the Association shall be held at the principal office of the Association or at such other suitable place convenient to the Members as the Board may designate.

2.3 Annual Meetings. The first meeting of the Association, whether a regular or special meeting, shall be held at such time as in the sole discretion of the Declarant that sufficient Units are owner-occupied as to warrant an Association meeting. Meetings shall be of Members and, if required by law, shall be open to all Members. Subsequent regular annual meetings shall be set by the Board to occur during the third quarter of the Association's fiscal year on a date and at a time set by the Board.

2.4 Special Meetings. Subject to the Declarant's discretion, the President may call special meetings. In addition, it shall be the duty of the President, subject to Declarant approval, to call a special meeting if so directed by resolution of the Board, upon a petition signed by Members representing at least 25% of the total Class "A" votes of the Association.

2.5 Notice of Meetings. Written or printed notice stating the place, day, and hour of any meeting of Members shall be posted at each entrance to Trailwoods or delivered, either personally or by mail, to each Member entitled to vote at such meeting, and, if required by law, to all Members not less than 10 nor more than 60 days before the date of such meeting, by or at the direction of the President or the Secretary or the officers or persons calling the meeting.

In the case of a special meeting or when otherwise required by statute or these Bylaws, the purpose or purposes for which the meeting is called shall be stated in the notice. No business shall be transacted at a special meeting except as stated in the notice.

If mailed, the notice of a meeting shall be deemed to be delivered three days after deposit in the United States mail addressed to the Member at such Member's address as it appears on the records of the Association, with postage prepaid. If posted, the notice of a meeting shall be deemed delivered three days after such notice is posted at each entrance to Trailwoods.

2.6 Waiver of Notice. Waiver of notice of a meeting of Members shall be deemed the equivalent of proper notice. Any Member may waive, in writing, notice of any meeting of Members, either before or after such meeting. Attendance at a meeting by a Member shall be deemed a waiver by such Member of notice of the time, date, and place thereof, unless such Member specifically objects to lack of proper notice at the time the meeting is called to order. Attendance at a special meeting shall be deemed a waiver of notice of all business transacted at such meeting, unless an objection on the basis of lack of proper notice is raised before the business is put to a vote.

2.7 Adjournment of Meetings. If any meeting of the Association cannot be held because a quorum is not present, a majority of Members who are present at such meeting may adjourn the meeting to a time not less than five nor more than 30 days from the time the original meeting was called. At the reconvened meeting, if a quorum is present, any business may be transacted which might have been transacted at the meeting originally called. If a time and place for reconvening the meeting is not fixed by those in attendance at the original meeting or if for any reason a new date is fixed for reconvening the meeting after adjournment, notice of the time and place for reconvening the meeting shall be given to Members in the manner prescribed for regular meetings.

Members present at a duly called or held meeting at which a quorum is present may continue to do business until adjournment, notwithstanding the withdrawal of enough Members to leave less than a quorum, provided that any action taken is approved by at least a majority of the votes required to constitute a quorum.

2.8 Voting. The voting rights of the Members shall be as set forth in the Declaration and in these Bylaws, and such voting rights provisions in the Declaration are specifically incorporated herein by this reference.

2.9 Proxies. On any matter as to which a Member is entitled personally to cast the vote for a Unit, such vote may be cast in person, by written ballot, or by proxy, subject to the limitations of Oklahoma law relating to use of general proxies and subject to any specific provision to the contrary in the Declaration or these Bylaws.

Every proxy shall be in writing specifying the Unit for which it is given, signed by the Member or such Member's duly authorized attorney-in-fact, dated, and filed with the Secretary of the Association prior to the meeting for which it is to be effective. If such proxies have not been properly completed or returned in a timely fashion to the Secretary and a Member or such

Member's duly authorized attorney-in-fact does not personally appear at a meeting, the vote of the Member shall be deemed to have been given to the Declarant for quorum and voting purposes. Unless otherwise specifically provided in the proxy, a proxy shall be presumed to cover all votes which the Member giving such proxy is entitled to cast. In the event of any conflict between two or more proxies purporting to cover the same voting rights, the later dated proxy shall prevail, or if dated as of the same date, both shall be deemed invalid; however, such conflicting proxies shall be counted for purposes of determining the presence of a quorum.

Every proxy shall be revocable and shall automatically cease upon: (a) conveyance of any Unit for which it was given; (b) receipt by the Secretary of written notice of revocation of the proxy or of the death or judicially declared incompetence of a Member who is a natural person; or (c) on the date specified in the proxy.

2.10 Majority. As used in these Bylaws, the term "majority" shall mean those votes, Owners, or other group as the context may indicate, totaling more than 50% of the total eligible number thereof.

2.11 Quorum. Except as otherwise provided in these Bylaws or in the Declaration, the presence of Members representing a majority of the total Class "A" votes in the Association shall constitute a quorum at all meetings of the Association. Any Member or their duly authorized attorney-in-fact not personally present at a meeting and who has not properly completed or returned their proxy in a timely fashion to the Secretary shall be deemed to have given to the Declarant the vote of such Member for quorum and voting purposes.

2.12 Conduct of Meetings. The President shall preside over all meetings of the Association and the Secretary shall keep the minutes of the meetings and record in a minute book all resolutions adopted and all other transactions occurring at such meetings.

2.13 Action Without a Meeting. Any action required or permitted by law to be taken at a meeting of Members may be taken without a meeting, without prior notice and without a vote if written consent specifically authorizing the proposed action is signed by Members holding at least the minimum number of votes necessary to authorize such action at a meeting if all Members entitled to vote thereon were present. Such consents shall be signed within 60 days after receipt of the earliest dated consent, dated and delivered to the Association. Such consents shall be filed with the minutes of the Association and shall have the same force and effect as a vote of Members at a meeting. Within 10 days after receiving authorization for any action by written consent, the Secretary shall give notice to all Members entitled to vote who did not give their consent, fairly summarizing the material features of the authorized action.

Article 3 Board of Directors: Number, Powers, Meetings

A. COMPOSITION AND SELECTION.

3.1 Governing Body; Composition. The affairs of the Association shall be governed by a Board of Directors, each of whom shall have one vote. Except with respect to directors

appointed by the Class "B" Member, the directors shall be Members or residents; provided, however, no Owner and resident representing the same Unit may serve on the Board at the same time. A "resident" shall be any natural person 18 years of age or older whose principal residence is a Unit within Trailwoods. In the case of a Member which is not a natural person, any officer, director, partner or trust officer of such Member shall be eligible to serve as a director unless otherwise specified by written notice to the Association signed by such Member; provided, no Member may have more than one such representative on the Board at a time, except in the case of directors appointed by the Class "B" Member.

3.2 Number of Directors. The Board shall consist of no less than three or more than nine directors, as provided in Articles 3.3 and 3.5 below. The initial Board shall consist of three directors as identified in the Articles of Incorporation.

3.3 Directors During Class "B" Control Period. Subject to the provisions of Article 3.5, the directors shall be selected by the Class "B" Member acting in its sole discretion and shall serve at the pleasure of the Class "B" Member until the first to occur of the following:

- (a) when the Class B Control Period should cease; or
- (c) when, in its discretion, the Class "B" Member so determines.

3.4 Nomination and Election Procedures.

(1) **Nominations and Declarations of Candidacy.** Prior to each election of directors, the Board shall prescribe the opening date and the closing date of a reasonable filing period in which each and every eligible person who has a bona-fide interest in serving as a director may file as a candidate for any position to be filled by Class "A" votes. The Board shall also establish such other rules and regulations as it deems appropriate to conduct the nomination of directors in a fair, efficient, and cost-effective manner.

Except with respect to directors selected by the Class "B" Member, nominations for election to the Board may also be made by a Nominating Committee. The Nominating Committee, if any, shall consist of a Chairman, who shall be a member of the Board, and three or more Members or representatives of Members. The members of the Nominating Committee shall be appointed by the Board not less than 30 days prior to each annual meeting to serve a term of one year and until their successors are appointed, and such appointment shall be announced in the notice of each election.

The Nominating Committee may make as many nominations for election to the Board as it shall, in its discretion, determine. The Nominating Committee shall nominate separate slates for the directors, if any, to be elected at large by all Class "A" votes. In making its nominations, the Nominating Committee shall use reasonable efforts to nominate candidates representing the diversity which exists within the pool of potential candidates.

Each candidate shall be given a reasonable, uniform opportunity to communicate qualifications to the Members and to solicit votes.

(2) Election Procedures. Each Member may cast all votes assigned to the Units which such Member represents for each position to be filled from the slate of candidates on which such Member is entitled to vote. There shall be no cumulative voting. That number of candidates equal to the number of positions to be filled receiving the greatest number of votes shall be elected. Directors may be elected to serve any number of consecutive terms.

3.5 Election and Term of Office. Notwithstanding any other provision of these Bylaws:

(1) During the Class "B" Control Period, the Declarant shall have the right in its sole discretion to appoint each member of the Board. The Declarant may, but shall not be required to, appoint a resident Owner to the Board during the Class "B" Control Period. The fact that the Declarant has in the past appointed a resident Owner to the Board shall not require the Declarant to continue with such appointments.

(2) After termination of the Class "B" Control Period, the Class "B" Member shall be entitled to appoint one director, unless the Declarant waives such right in a Recorded instrument. Such director shall be elected for a term of two years and shall not be subject to removal by the Members. Upon the sole discretion of the Class B Member, the Class B Member appointee may resign, their position to be filled by the Members at the next election of directors. Within 90 days after termination of the Class "B" Control Period, the Board shall be increased to nine directors and an election shall be held. Eight directors shall be elected by Members. Four directors shall serve a term of two years, and four directors shall serve a term of one year, as such directors determine among themselves. The directors elected by Members shall not be subject to removal by the Class "B" Member.

Upon the expiration of the term of office of each director elected by Members, Members entitled to elect such director shall be entitled to elect a successor to serve a term of two years. The directors elected by Members shall hold office until their respective successors have been elected.

3.6 Removal of Directors and Vacancies. Any director elected by Members may be removed, with or without cause, by the vote of Members holding a majority of the votes entitled to be cast for the election of such director. Any director whose removal is sought shall be given notice prior to any meeting called for that purpose. Upon removal of a director, a successor shall be elected by Members entitled to elect the director so removed to fill the vacancy for the remainder of the term of such director.

Any director elected by Members who has three consecutive unexcused absences from Board meetings, or who is more than 30 days delinquent (or is the representative of a Member who is so delinquent) in the payment of any assessment or other charge due the Association, may be removed by a majority of the directors present at a regular or special meeting at which a quorum is present, and the Board may appoint a successor to fill the vacancy for the remainder of the term.

In the event of the death, disability, or resignation of a director, the Board may declare a vacancy and appoint a successor to fill the vacancy until the next annual meeting, at which time Members entitled to fill such directorship may elect a successor for the remainder of the term.

This Article shall not apply to directors appointed by the Class "B" Member. The Class "B" Member shall be entitled to appoint a successor to fill any vacancy on the Board resulting from the death, disability, or resignation of a director appointed by or elected as a representative of the Class "B" Member.

B. MEETINGS.

3.7 Organizational Meetings. The first meeting of the Board following each annual meeting of the membership shall be held within 10 days thereafter at such time and place the Board shall fix.

3.8 Regular Meetings. Regular meetings of the Board may be held at such time and place a majority of the directors shall determine, but at least four such meetings shall be held during each fiscal year with at least one per quarter. Notice of the time and place of a regular meeting shall be communicated to directors not less than four days prior to the meeting; provided, however, notice of a meeting need not be given to any director who has signed a waiver of notice or a written consent to holding of the meeting.

3.9 Special Meetings. Special meetings of the Board shall be held when called by written notice signed by the President or Vice President or by any two directors. The notice shall specify the time and place of the meeting and the nature of any special business to be considered. The notice shall be given to each director by: (a) personal delivery; (b) first class mail, postage prepaid; (c) telephone communication, either directly to the director or to a person at the director's office or home who would reasonably be expected to communicate such notice promptly to the director; or (d) facsimile, computer, fiber optics or such other communication device. All such notices shall be given at the director's telephone number, fax number, electronic mail number, or sent to the director's address as shown on the records of the Association. Notices sent by first class mail shall be deposited into a United States mailbox at least seven business days before the time set for the meeting. Notices given by personal delivery, telephone, or other device shall be delivered or transmitted at least 72 hours before the time set for the meeting.

3.10 Waiver of Notice. The transactions of any meeting of the Board, however called and noticed or wherever held, shall be as valid as though taken at a meeting duly held after regular call and notice if (a) a quorum is present, and (b) either before or after the meeting each of the directors not present signs a written waiver of notice, a consent to holding the meeting, or an approval of the minutes. The waiver of notice or consent need not specify the purpose of the meeting. Notice of a meeting also shall be deemed given to any director who attends the meeting without protesting before or at its commencement about the lack of adequate notice.

3.11 Telephonic Participation in Meetings. Members of the Board or any committee designated by the Board may participate in a meeting of the Board or committee by means of conference telephone or similar communications equipment, by means of which all

persons participating in the meeting can hear each other. Participation in a meeting pursuant to this subArticle shall constitute presence in person at such meeting.

3.12 Quorum of Board. At all meetings of the Board, a majority of the directors shall constitute a quorum for the transaction of business, and the votes of a majority of the directors present at a meeting at which a quorum is present shall constitute the decision of the Board, unless otherwise specifically provided in these Bylaws or the Declaration. A meeting at which a quorum is initially present may continue to transact business, notwithstanding the withdrawal of directors, if any action taken is approved by at least a majority of the required quorum for that meeting. If any meeting of the Board cannot be held because a quorum is not present, a majority of the directors present at such meeting may adjourn the meeting to a time not less than five nor more than 30 days from the date of the original meeting. At the reconvened meeting, if a quorum is present, any business which might have been transacted at the meeting originally called may be transacted without further notice.

3.13 Compensation. Directors shall not receive any compensation from the Association for acting as such unless approved by Members representing a majority of the total Class "A" votes in the Association at a regular or special meeting of the Association. Any director may be reimbursed for expenses incurred on behalf of the Association upon approval of a majority of the other directors. Nothing herein shall prohibit the Association from compensating a director, or any entity with which a director is affiliated, for services or supplies furnished to the Association in a capacity other than as a director pursuant to a contract or agreement with the Association, provided that such director's interest was made known to the Board prior to entering into such contract and such contract was approved by a majority of the Board, excluding the interested director.

3.14 Conduct of Meetings. The President shall preside over all meetings of the Board, and the Secretary shall keep a minute book of Board meetings, recording all Board resolutions and all transactions and proceedings occurring at such meetings.

3.15 Notice to Owners; Open Meetings. Except in an emergency, notice of the time and place of Board meetings shall be posted at least 48 hours in advance of the meeting at a conspicuous place within Trailwoods which the Board establishes for the posting of notices relating to the Association. Notice of any meeting at which assessments are to be established shall state that fact and the nature of the assessment. Subject to the provisions of Article 3.16, all meetings of the Board shall be open to all Members and, if required by law, all Owners, but attendees other than directors may not participate in any discussion or deliberation unless permission to speak is authorized by a vote of the majority of a quorum of the Board. In such case, the President may limit the time any such individual may speak. Notwithstanding the above, the President may adjourn any meeting of the Board and reconvene in executive session, and may exclude persons other than directors, to discuss any or all of the following:

- (a) employment or personnel matters for employees of the Association;
- (b) legal advice from an attorney retained for the Board or the Association;
- (c) pending or contemplated litigation; or
- (d) pending or contemplated matters relating to enforcement of the Governing Documents.

3.16 Action Without a Formal Meeting. Any action to be taken at a meeting of the directors or any action that may be taken at a meeting of the directors may be taken without a meeting if a consent in writing, setting forth the action so taken, is signed by all of the directors, and such consent shall have the same force and effect as a unanimous vote.

C. POWERS AND DUTIES.

3.17 Powers. The Board of Directors shall have all of the powers and duties necessary for the administration of the Association's affairs and for performing all responsibilities and exercising all rights of the Association as set forth in the Declaration, these Bylaws, the Articles, and as provided by law. The Board may do or cause to be done all acts and things which the Declaration, Articles, these Bylaws, or Oklahoma law do not direct to be done and exercised exclusively by Members or the membership generally.

3.18 Duties. Subsequent to the Class "B" Control Period, the duties of the Board shall include, without limitation:

- (1) preparing and adopting, in accordance with the Declaration, an annual budget and establishing each Owner's share of the Common Expenses;
- (2) providing for the operation, care, upkeep, and maintenance of the Common Area;
- (3) designating, hiring, and dismissing the personnel necessary to carry out the rights and responsibilities of the Association and where appropriate, providing for the compensation of such personnel and for the purchase of equipment, supplies, and materials to be used by such personnel in the performance of their duties;
- (4) depositing all funds received on behalf of the Association in a bank depository which it shall approve, and using such funds to operate the Association; provided, any reserve funds may be deposited, in the Board's best business judgment, in depositories other than banks;
- (5) making and amending use restrictions and rules in accordance with the Declaration;
- (6) opening of bank accounts on behalf of the Association and designating the signatories required;
- (7) making or contracting for the making of repairs, additions, and improvements to or alterations of the Common Area in accordance with the Declaration and these Bylaws;
- (8) enforcing the provisions of the Declaration, these Bylaws, and the rules adopted pursuant thereto and bringing any legal proceedings which may be instituted on behalf of or against the Owners concerning the Association; provided, the Association shall not be obligated to take action to enforce any covenant, restriction or rule which the Board in the exercise of its business judgment determines is, or is likely to be construed as, inconsistent with applicable law, or in any case in which the Board reasonably determines that the Association's position is not strong enough to justify taking enforcement action;
- (9) obtaining and carrying property and liability insurance and fidelity bonds, as provided in the Declaration, paying the cost thereof, and filing and adjusting claims, as appropriate;
- (10) paying the cost of all services rendered to the Association;
- (11) keeping books with detailed accounts of the receipts and expenditures of the Association;
- (12) permitting utility suppliers to use portions of the Common Area reasonably necessary to the ongoing development or operation of the Properties;
- (13) indemnifying a director, officer or committee member, or former director, officer, or

committee member of the Association to the extent such indemnity is authorized by Oklahoma law, the Articles of Incorporation, or the Declaration;

(14) assisting in the resolution of disputes between Owners and others without litigation, as set forth in the Declaration;

3.19 Right of Class "B" Member to Disapprove Actions. So long as the Class "B" membership exists, the Class "B" Member shall have a right to disapprove any action, policy or program of the Association, the Board and any committee which, in the sole judgment of the Class "B" Member, would tend to impair rights of Declarant or Builders under the Governing Documents, or interfere with development or construction of any portion of Trailwoods, or diminish the level of services being provided by the Association.

(1) Notice. The Class "B" Member shall be given written notice of all meetings and proposed actions approved at meetings (or by written consent in lieu of a meeting) of the Association, the Board, or any committee. Such notice shall be given by certified mail, return receipt requested, or by personal delivery at the address it has registered with the Secretary of the Association, which notice complies as to the Board meetings with Articles 3.8, 3.9, 3.10, and 3.11 and which notice shall, except in the case of the regular meetings held pursuant to the Bylaws, set forth with reasonable particularity the agenda to be followed at such meeting.

(2) Opportunity To Be Heard. The Class "B" Member shall be given the opportunity at any such meeting to join in or to have its representatives or agents join in discussion from the floor of any prospective action, policy, or program which would be subject to the right of disapproval set forth herein.

No action, policy, or program subject to the right of disapproval set forth herein shall become effective or be implemented until and unless the requirements of subArticles (1) and (2) above have been met.

The Class "B" Member, through its representatives or agents, shall make its concerns, thoughts, and suggestions known to the Board and/or the members of the subject committee. The Class "B" Member, acting through any officer or director, agent, or authorized representative, may exercise its right to disapprove at any time within 10 days following the meeting at which such action was proposed or, in the case of any action taken by written consent in lieu of a meeting, at any time within 10 days following receipt of written notice of the proposed action. This right to disapprove may be used to block proposed actions but shall not include a right to require any action or counteraction on behalf of any committee, the Board, or the Association. The Class "B" Member shall not use its right to disapprove to reduce the level of services which the Association is obligated to provide or to prevent capital repairs or any expenditure required to comply with applicable laws and regulations.

3.20 Management. The Board may employ for the Association a professional manager agent or agents at such compensation as the Board may establish, to perform such duties and services as the Board shall authorize. The manager may be a corporation or an individual. The Board may delegate such powers as are necessary to perform the manager's assigned duties but shall not delegate policymaking authority or those non-delegable duties set forth in Articles

3.18(1), 3.18(2), 3.18(5)-(6), 3.18(8) and 3.18(13)-(14). Declarant or an affiliate of Declarant may be employed as managing agent or manager.

The Board may delegate to one of its members the authority to act on behalf of the Board on all matters relating to the duties of the manager, if any, which might arise between meetings of the Board.

The Association shall not be bound, either directly or indirectly, by any management contract executed during the Class "B" Control Period unless such contract contains a right of termination exercisable by the Association, with or without cause and without penalty, at any time after termination of the Class "B" Control Period upon not more than 90 days' written notice.

3.21 Accounts and Reports. The following management standards of performance shall be followed unless the Board by resolution specifically determines otherwise:

- (1) cash accounting, as defined by generally accepted accounting principles, shall be employed;
- (2) accounting and controls should conform to generally accepted accounting principles;
- (3) cash accounts of the Association shall not be commingled with any other accounts;
- (4) no remuneration shall be accepted by the manager from vendors, independent contractors, or others providing goods or services to the Association, whether in the form of commissions, finder's fees, service fees, prizes, gifts, or otherwise; any thing of value received shall benefit the Association;
- (5) any financial or other interest which the manager may have in any firm providing goods or services to the Association shall be disclosed promptly to the Board;
- (6) commencing at the end of the quarter in which the first Unit is sold and closed, financial reports shall be prepared for the Association at least quarterly containing:
 - (i) an income statement reflecting all income and expense activity for the preceding period on an accrual basis;
 - (ii) a statement reflecting all cash receipts and disbursements for the preceding period;
 - (iii) a variance report reflecting the status of all accounts in an "actual" versus "approved" budget format;
 - (iv) a balance sheet as of the last day of the preceding period; and
 - (v) a delinquency report listing all Owners who are delinquent in paying any assessments at the time of the report and describing the status of any action to collect such assessments which remain delinquent (any assessment or installment thereof shall be considered to be delinquent on the 15th day following the due date unless otherwise specified by Board resolution); and
- (7) an annual report consisting of at least the following shall be made available to all Members within 120 days after the close of the fiscal year: (i) a balance sheet; (ii) an operating (income) statement; and (iii) a statement of changes in financial position for the fiscal year. Such annual report shall be prepared on an audited, reviewed, or compiled basis, as the Board determines, by an independent public accountant; provided, upon written request of any holder, guarantor, or insurer of any first Mortgage on a Unit, the Association shall provide an audited financial statement. During the Class "B" Control Period, the annual report shall include certified financial statements.

3.22 Borrowing. The Association shall have the power to borrow money for any legal purpose; provided, the Board shall obtain Member approval in the same manner provided in Section 8.3 of the Declaration for Special Assessments if the proposed borrowing is for the purpose of making discretionary capital improvements and the total amount of such borrowing, together with all other debt incurred within the previous 12-month period, exceeds or would exceed 10% of the budgeted gross expenses of the Association for that fiscal year. During the Class "B" Control Period, no Mortgage lien shall be placed on any portion of the Common Area without the affirmative vote or written consent, or any combination thereof, of Members representing at least 51% of the total Class "A" votes in the Association.

3.23 Right To Contract. The Association shall have the right to contract with any Person for the performance of various duties and functions. This right shall include, without limitation, the right to enter into common management, operational, or other agreements with trusts, condominiums, cooperatives, and other owners or residents associations, within and outside the Properties. Any common management agreement shall require the consent of an absolute majority of the Board.

3.24 Enforcement. The Association shall have the power, as provided in the Declaration, to impose sanctions for any violation of any duty imposed under Trailwoods Governing Documents. In the event that any occupant, tenant, employee, guest, or invitee of a Unit violates the Declaration, Bylaws, or a rule and a fine is imposed, the fine shall first be assessed against the occupant; Provided, however, if the fine is not paid by the occupant within the time period set by the Board, the Owner shall pay the fine upon notice from the Association.

The Association shall not be obligated to take any enforcement action if the Board reasonably determines that the Association's position is not strong enough to justify taking such action. Such a decision shall not be construed a waiver of the right of the Association to enforce such provision at a later time under other circumstances or estop the Association from enforcing any other covenant, restriction, or rule.

The Association, by contract or other agreement, may, but shall not be obligated to, enforce applicable city and county ordinances, if applicable, and may, but shall not be obligated to, permit Cleveland County or the City of Norman to enforce ordinances within the Properties for the benefit of the Association and its Members.

In conducting the business of the Association, the Board, at all times, shall act within the scope of Trailwoods Governing Documents and in good faith to further the legitimate interests of the Association and its Members. In fulfilling its governance responsibilities, the Board shall limit its actions to those reasonably related to the Association's purposes; those reasonably related to or within the Association's powers, as provided by Trailwoods Governing Documents and as provided by the laws of the State of Oklahoma; and those that are reasonable in scope. The Board shall exercise its power in a fair and nondiscriminatory manner and shall adhere to the procedures established in Trailwoods Governing Documents.

(1) **Notice.** Prior to imposition of any sanction hereunder or under the Declaration, the Board

or its delegate shall serve the alleged violator with written notice describing (i) the nature of the alleged violation; (ii) the proposed sanction to be imposed; (iii) a period of not less than 10 days within which the alleged violator may present a written request for a hearing to the Board or the Covenants Committee, if one has been appointed pursuant to Article 5; and (iv) a statement that the proposed sanction shall be imposed as contained in the notice unless a challenge is begun within 10 days of the notice. If a timely challenge is not made, the sanction stated in the notice shall be imposed; provided that the Board or Covenants Committee may, but shall not be obligated to, suspend any proposed sanction if the violation is cured within the 10-day period. Such suspension shall not constitute a waiver of the right to sanction future violations of the same or other provisions and rules by any Person.

(2) Hearing. If a hearing is requested within the allotted 10-day period, the hearing shall be held before the Covenants Committee, or if none has been appointed, then before the Board in executive session. The alleged violator shall be afforded a reasonable opportunity to be heard. Prior to the effectiveness of any sanction hereunder, proof of proper notice shall be placed in the minutes of the meeting. Such proof shall be deemed adequate if a copy of the notice, together with a statement of the date and manner of delivery, is entered by the Person, who delivered such notice. The notice requirement shall be deemed satisfied if the alleged violator or its representative appears at the meeting. The minutes of the meeting shall contain a written statement of the results of the hearing and the sanction, if any, imposed.

(3) Appeal. Following a hearing before the Covenants Committee, the violator shall have the right to appeal the decision to the Board. To exercise this right, a written notice of appeal must be received by the manager, President, or Secretary of the Association within 10 days after the hearing date.

(4) Additional Enforcement Rights. Notwithstanding anything to the contrary in this Article, the Board may elect to enforce any provision of the Declaration, these Bylaws, or the rules of the Association by self-help (specifically including, but not limited to, the towing of vehicles that are in violation of parking rules) or, following compliance with the dispute resolution procedures set forth in Section 12 of the Declaration, if applicable, by suit at law or in equity to enjoin any violation or to recover monetary damages or both, without the necessity of compliance with the procedure set forth above. In any such action, to the maximum extent permissible, the Owner or occupant responsible for the violation of which abatement is sought shall pay all costs, including reasonable attorney's fees actually incurred. Any entry onto a Unit for purposes of exercising this power of self-help shall not be deemed a trespass.

Article 4 Officers

4.1 Officers. The officers of the Association shall be a President, Vice President, Secretary, and Treasurer. The President and Secretary shall be elected from among the members of the Board; other officers may, but need not be members of the Board. The Board may appoint such other officers, including one or more Assistant Secretaries and one or more Assistant Treasurers, as it shall deem desirable, such officers to have such authority and perform such duties as the Board prescribes. Any two or more offices may be held by the same person, except the offices of President and Secretary.

4.2 Election and Term of Office. The Board shall elect the officers of the Association at the first meeting of the Board following each annual meeting of Members, to serve until their successors are elected.

4.3 Removal and Vacancies. The Board may remove any officer whenever in the Board's judgment the best interests of the Association will be served, and may fill any vacancy in any office arising because of death, resignation, removal, or otherwise, for the unexpired portion of the term.

4.4 Powers and Duties. The officers of the Association each shall have such powers and duties as generally pertain to their respective offices, as well as such powers and duties as may specifically be conferred or imposed by the Board of Directors. The President shall be the chief executive officer of the Association. The Treasurer shall have primary responsibility for the preparation of the budget provided for in the Declaration and may delegate all or part of the preparation and notification duties to a finance committee, manager, or both.

4.5 Resignation. Any officer may resign at any time by giving written notice to the Board, the President, or the Secretary. Such resignation shall take effect on the date of the receipt of such notice or at any later time specified therein, and unless otherwise specified therein, the acceptance of such resignation shall not be necessary to make it effective.

4.6 Agreements, Contracts, Deeds, Leases, Checks, Etc. All agreements, contracts, deeds, leases, checks, and other instruments of the Association shall be executed by at least two officers or by such other person or persons as may be designated by Board resolution.

4.7 Compensation. Compensation of officers shall be subject to the same limitations as compensation of directors under Article 3.13.

Article 5 Committees

5.1 General. The Board may appoint such committees as it deems appropriate to perform such tasks and to serve for such periods as the Board may designate by resolution. Each committee shall operate in accordance with the terms of such resolution.

5.2 Covenants Committee. In addition to any other committees which the Board may establish pursuant to Article 5.1, the Board may appoint a Covenants Committee consisting of at least three and no more than seven Members. Acting in accordance with the provisions of the Declaration, these Bylaws, and resolutions the Board may adopt, the Covenants Committee, if established, shall be the hearing tribunal of the Association and shall conduct all hearings held pursuant to Article 3.24 of these Bylaws.

Article 6 Miscellaneous

6.1 Fiscal Year. The fiscal year of the Association shall be a calendar year, unless the Board

establishes a different fiscal year by resolution.

6.2 Parliamentary Rules. Except as may be modified by Board resolution, Robert's Rules of Order (current edition) shall govern the conduct of Association proceedings when not in conflict with Oklahoma law, the Articles of Incorporation, the Declaration, or these Bylaws.

6.3 Conflicts. If there are conflicts among the provisions of Oklahoma law, the Articles of Incorporation, the Declaration, and these Bylaws, the provisions of Oklahoma law (unless displaceable by the Governing Documents), the Declaration, the Articles of Incorporation, and the Bylaws (in that order) shall prevail.

6.4 Books and Records.

(1) Inspection by Members and Mortgagees. The Board shall make available for inspection and copying by any holder, insurer or guarantor of a first Mortgage on a Unit, any Member, or the duly appointed representative of any of the foregoing at any reasonable time and for a purpose reasonably related to his or her interest in a Unit: the Declaration, Bylaws, and Articles of Incorporation, including any amendments, the rules of the Association, the membership register, books of account, including financial records, and the minutes of meetings of the Members, the Board, and committees. The Board shall provide for such inspection to take place at the office of the Association or at such other place within the Properties as the Board shall designate.

(2) Rules for Inspection. The Board shall establish rules with respect to: (i) notice to be given to the custodian of the records; (ii) hours and days of the week when such an inspection may be made; and (iii) payment of the cost of reproducing documents requested.

(3) Inspection by Directors. Every director shall have the absolute right at any reasonable time to inspect all books, records, and documents of the Association and the physical properties owned or controlled by the Association. The right of inspection by a director includes the right to make a copy of relevant documents at the expense of the Association.

(4) Exceptions to Inspection Requirement. Notwithstanding any provision to the contrary, the Board shall not be required to make available for inspection any portion of any book or record which relates to any of the following:

- (i) personnel matters or a person's medical records;
- (ii) communication between an attorney for the Association and the Association;
- (iii) pending or contemplated litigation;
- (iv) pending or contemplated matters relating to enforcement of the Governing Documents; or
- (v) meeting minutes or other records of a session of a Board or Association meeting that is not required by law to be open to all Members.

In addition, the Board shall not be required to disclose or make available for inspection any financial or other records of the Association if disclosure would violate local, state, or federal law.

6.5 Notices. Except as otherwise provided in the Declaration or these Bylaws, all notices, demands, bills, statements, or other communications under the Declaration or these Bylaws shall

be in writing and shall be deemed to have been duly given if posted at each entrance to Trailwoods, delivered personally, or if sent by United States mail, first class postage prepaid:

(1) if to a Member or Member, at the address which the Member or Member has designated in writing and filed with the Secretary or, if no such address has been designated, at the address of the Unit of such Member or Member;

(2) if to the Association, the Board, or the manager, at the principal office of the Association or the managing agent or at such other address as shall be designated by notice in writing to the Members pursuant to this Article; or

(3) if to any committee, at the principal address of the Association or at such other address as shall be designated by notice in writing to the Members pursuant to this Article.

6.6 Amendment.

(1) **By Class "B" Member.** Prior to termination of the Class "B" Control Period, the Class "B" Member may unilaterally amend these Bylaws. Thereafter, the Class "B" Member may unilaterally amend these Bylaws at any time and from time to time if such amendment is necessary (i) to bring any provision into compliance with any applicable governmental statute, rule or regulation, or judicial determination; (ii) to enable any reputable title insurance company to issue title insurance coverage on the Units; or (iii) to enable any institutional or governmental lender, purchaser, insurer or guarantor of mortgage loans, including, for example, the Federal National Mortgage Association or Federal Home Loan Mortgage Corporation, to make, purchase, insure or guarantee mortgage loans on the Units. However, any such amendment shall not adversely affect the title to any Unit unless the Owner shall consent thereto in writing. So long as the Class "B" membership exists, the Class "B" Member may unilaterally amend these Bylaws for any other purpose, provided the amendment has no material adverse effect upon any right of any Member.

(2) **By Members Generally.** Except as provided above and Oklahoma law, these Bylaws may be amended only by the affirmative vote or written consent, or any combination thereof, of Members representing 51% of the total Class "A" votes in the Association, and the consent of the Class "B" Member, if such exists. In addition, the approval requirements set forth in Section 13 of the Declaration shall be met, if applicable. Notwithstanding the above, the percentage of votes necessary to amend a specific clause shall not be less than the prescribed percentage of affirmative votes required for action to be taken under that clause.

(3) **Validity and Effective Date of Amendments.** Amendments to these Bylaws shall become effective upon Recordation unless a later effective date is specified therein. Any procedural challenge to an amendment must be made within six months of its Recordation, or such amendment shall be presumed to have been validly adopted. In no event shall a change of conditions or circumstances operate to amend any provisions of these Bylaws.

No amendment may remove, revoke, or modify any right or privilege of Declarant or the Class "B" Member without the written consent of Declarant, the Class "B" Member, or the assignee of such right or privilege.

CERTIFICATION

I, the undersigned, do hereby certify: I am the duly elected and acting Secretary of Trailwoods Property Owners Association, Inc., an Oklahoma corporation; the foregoing Bylaws constitute the original Bylaws of said Association, as duly adopted at a meeting of the Board of Directors thereof held on the 4th day of October, 2005.

IN WITNESS WHEREOF, I have hereunto subscribed my name as representative of the Association the same date as written above.

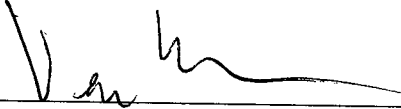

Secretary: _____

EXHIBIT "E"

Calculation of Base Assessments

Unit

\$100.00

Exhibit "F"

Design Review Guidelines for Trailwoods a residential community

DISCLAIMER

All plans, dimensions, improvements, amenities, features, uses, specifications, materials and availability depicted herein are subject to change without notice. Any illustrations are for depiction only and may differ from completed improvements.

These Design Review Guidelines are not intended to be a complete list of all criteria that must be satisfied in connection with construction of improvements. Compliance with these guidelines does not assure approval of any particular designs. Declarant, or DRB as the case may be, reserves the right to approve particular designs which vary from or otherwise do not comply with these guidelines.

These architectural guidelines are a mechanism for maintaining and enhancing the overall aesthetics of Trailwoods; they do not create any duty to any person. Review and approval of any designs may be based on aesthetic considerations only. Declarant, Trailwoods Property Owners Association, or the DRB shall not bear any responsibility for ensuring the structural integrity or soundness of approved construction or modifications, for ensuring compliance with building codes and other governmental requirements, or for ensuring that every structure is of comparable quality, value, or size, of similar design, or aesthetically pleasing or otherwise acceptable to other owners of property in Trailwoods. Declarant makes no warranty, express or implied, that the information or guidelines contained herein are suitable for any particular use, and hereby disclaims any liability in connection with the use of this information.

1. INTRODUCTION

1.1. Purpose.

Trailwoods is a planned community comprising real property within the City of Norman, Cleveland County, State of Oklahoma. The purpose of the Trailwoods development is to provide a high quality, aesthetically pleasing residential community, while preserving the natural beauty of the area and enhancing the value of each Owner's investment. The purpose of the Design Review Guidelines (DRG) and Design Review Board (DRB) is to meet the overall Trailwoods purpose by assisting in the building design process. As a general rule, the DRG and DRB will not dictate any particular architectural style or hinder personal design preferences. The DRG and DRB will strive to maintain an aesthetic flow between the interrelated sections. Traditional design details may be incorporated in the DRG, but any styles that tend to disrupt aesthetic harmony will be discouraged.

1.2. Scope.

The Design Review Guidelines and Design Review Board oversight apply to all Modifications, as defined in the Declaration. Modifications include new construction and the alteration of or additions to existing construction.

1.3. Amendments.

The Design Review Board may amend, cancel, add to, modify, or otherwise change these Design Review Guidelines from time to time as necessary in the DRB's sole discretion. The DRB shall send notice of any changes by mail to all Owners at least five business days prior to implementation of any new design guideline. Such mailing, or failure thereof, shall not relieve each Owner of their obligation to determine applicable design guidelines prior to making any new construction or Modification.

1.4. Compliance with Local Law.

The DRB is not responsible for notice of or ensuring compliance with building codes, structural details, local, state, federal law, or environmental agency compliance.

1.5. Limitation of Liability.

The DRB is not responsible and shall bear no liability for the accuracy of drawings and techniques of construction. The DRB shall bear no liability and is not responsible for workmanship, safety, or quality of new construction or Modification based upon its review and decision of an application.

2. DESIGN REVIEW PROCEDURES

2.1. Applicability.

The Design Review Guidelines apply to all new construction and Modifications. Other examples include by illustration only antenna and satellite receivers, outdoor sculptures or artwork, storm doors, security doors, windows, storm windows and siding.

2.2. Design Review Board.

Oversight of the DRG is vested in the Design Review Board, unless otherwise delegated

or assigned to an Architectural Review Committee. The DRB shall consist of at least three and no more than five persons appointed by and serving at the Board's discretion. Members of the DRB may include architects or similar professionals who are not Owners.

The DRB may adopt detailed application and review procedures and design standards governing its area of responsibility consistent with the Declaration. All new construction and Modifications shall take place in strict compliance with the Declaration, the Design Review Guidelines, and the application and review procedures promulgated by the Design Review Board.

2.3. Review Fees.

The DRB may establish a review fee schedule applicable to the oversight of administering the DRG.

2.4. Review Standards.

As provided in the Governing Documents, the DRB shall approve any new construction or Modification only if it deems, in its discretion, that new construction and Modifications conform to and harmonize with the existing surroundings, residences, landscaping, and structures, and meets the requirements for such new construction and Modifications found in the Governing Documents, Design Review Guidelines, and procedures promulgated by the DRB.

The DRB evaluates all submissions on the merits of the application. Besides evaluation of the particular design proposal, this includes the consideration of the characteristics of the housing type and the individual site.

Design decisions are not based on personal opinion or taste. Judgments of acceptable design are based on the following standards, which are presented in more specific form within Sections 3 and 4 to these Design Review Guidelines.

Compliance with the Governing Documents. All applications are reviewed to confirm that the proposed new construction or Modification is in conformance with the Governing Documents.

Relation to the Natural Environment. All applications are reviewed to confirm that the proposed new construction or Modification represents a positive or neutral effect on the surrounding natural environment. For example, fencing materials can have a deleterious effect on the feel of an open environment.

Validity of Concept. All applications are reviewed to confirm that the proposed new construction or Modification is sound in concept and appropriate to its surroundings.

Design Compatibility. All applications are reviewed to confirm that the proposed new construction or Modification is compatible with the architectural characteristics of existing structures both on the Unit and in the vicinity. Compatibility is defined as similarity in architectural style, quality of workmanship, similar use of materials, color, and construction details.

Location and Impact on Neighbors. All applications are reviewed to confirm that the proposed new construction or Modification relates favorably to the landscape, the existing structures on the Unit and in the vicinity. Primary issues of concern are access, drainage, sunlight, and ventilation. When new construction or Modification has particular impact upon Units in the vicinity, the DRB may require the applicant to discuss the proposal with Unit Owners in the vicinity prior to the DRB making a decision on the application. The DRB may also require the submittal of comments from Unit Owners in the vicinity.

Scale. All applications are reviewed to confirm that the proposed new construction or Modification relates well to the size, in three dimensions, of existing structures on Units in the vicinity. For example, additions to an existing structure that would place the square footage of the structures on a Unit in disproportion to structures on Units in the vicinity may be inappropriate.

Color. All applications are reviewed to confirm that the proposed new construction or Modification conforms to the colors represented on the existing structures on the Unit and on Units in the vicinity.

Materials. All applications are reviewed to confirm that the proposed new construction or Modification utilizes materials of the same or compatible nature as were used on existing structures on the Unit or on Units in the vicinity.

Workmanship. All applications are reviewed to confirm that the proposed new construction or Modification would entail workmanship of an equal or better quality than that represented on existing structures on the Unit or on Units in the vicinity.

Timing. All applications are reviewed to confirm that the proposed new construction or Modification may be completed in a timely manner, whether an Owner performs such work themselves or contracts the work to be done.

2.5. Review Process for New Construction and Modifications.

Prior to making application to the DRB, Owners are encouraged to meet with a representative of the DRB to avoid confusion about the approval process and to determine the acceptability of their design intent. The Owner should also obtain a current copy of the Design Review Guidelines and applicable forms.

Prior to commencing any new construction or Modifications, an Owner shall submit to the DRB an application for approval in such form as the DRB shall require. An acceptable application appears as Exhibit 1 to these Design Review Guidelines. Such application shall include plans and specifications ("Plans") showing site layout, structural design, exterior elevations, exterior materials and colors, landscaping, drainage, exterior lighting, irrigation, and other features of proposed construction, as applicable. The DRB, ARC, the Declaration, or the Design Review Guidelines may require the submission of such additional information as may be reasonably necessary to consider any application. For consideration, the application must be received by the DRB before 5:00 p.m. five days prior to the scheduled meeting of the DRB. The DRB will meet on a regular basis as determined by the DRB. Late submissions will not be

reviewed until the next meeting of the DRB.

In reviewing each submission, the DRB will consider the application based on the Review Standards. Decisions may be based on purely aesthetic considerations. Each Owner acknowledges that determinations as to such matters are purely subjective and opinions may vary as to the desirability and/or attractiveness of particular improvements.

Within 30 days after receipt of a completed application and all required information, the DRB shall respond in writing to the applicant at the address specified in the application. The response may (i) approve the application, with or without conditions; (ii) approve a portion of the application and disapprove other portions; or (iii) disapprove the application. The DRB may, but shall not be obligated to, specify the reasons for any objections and/or offer suggestions for curing any objections.

In the event that the DRB fails to respond to a properly submitted application in a timely manner, approval shall be deemed to have been given, subject to Declarant's right to veto approval by the DRB pursuant to this Section. Any approval inconsistent with the Declaration or the Design Review Guidelines is void unless a variance has been granted pursuant to Section 4.5 of the Declaration.

The DRB shall notify Declarant, so long as Declarant owns any property described in Exhibits "A" or "B," in writing within three business days after the DRB has approved any application relating to proposed Modifications unless Declarant waives, in writing, its right to such notification. The notice shall be accompanied by a copy of the application and any additional information which the Design Review Board may require. Declarant, so long as Declarant owns any property described in Exhibits "A" or "B," shall have 10 days after receipt of such notice to veto any such action, in the sole discretion of each, by written notice to the DRB and the applicant.

If construction does not commence on a new construction or Modifications project for which plans have been approved within one year after the date of approval, such approval shall be deemed withdrawn and the Owner shall reapply for approval before commencing the proposed Modifications. "Commencement" shall begin upon such actions as, but not limited to, delivery of materials and labor exerted relative to the new construction or Modification. After construction is commenced, it shall be diligently pursued to completion. All new construction or Modifications shall be completed within one year after commencement unless otherwise specified in the notice of approval or unless the DRB grants an extension in writing, which it shall not be obligated to do. Any new construction or Modifications not completed within the required time shall be considered nonconforming and shall be subject to enforcement action by the Design Review Board, the Association, Declarant or any aggrieved Owner.

The DRB, by resolution, may exempt certain activities from the application and approval requirements of this Section, provided such activities are undertaken in strict compliance with the requirements of such resolution. No approval shall be required to repaint the exterior of a structure in accordance with the originally approved color scheme or to rebuild in accordance with originally approved plans and specifications. Any Owner may remodel, paint or redecorate

the interior of a Unit without approval provided such alterations do not affect the aesthetics of the exterior of the Unit as they appear prior to the alteration. Modifications to the interior of screened porches, patios, and similar portions of a Unit visible from outside the structure shall be subject to approval. This Section shall not apply to the activities of Declarant, nor to activities of the Association during the Class "B" Control Period.

3. CONSTRUCTION GUIDELINES AND PROCEDURES

3.1. Construction Drawings.

All proposed new construction or Modification requires DRB review, which comes only as a result of a properly submitted application. The application must include construction drawings of the proposed improvement. Depending on the type of new construction or Modification, the DRB may require less or more construction drawings for a proper application. Construction drawings include, but are not limited to:

Site Plan. A site plan must be submitted with the application and will include:

- 4.1. **Site survey** with property lines or a site plan based on the recorded plat;
- 4.2. **Elevation drawings** showing elevations of the property corners, center of building or existing structures, culvert inlets, edge of roadway and finished floor elevations;
- 4.3. **Vegetation diagram** showing the location and species of trees 3" in diameter or larger at 48" from the ground;
- 4.4. **Setback lines**;
- 4.5. **Building outline** including service yard and front and rear corner of adjacent buildings;
- 4.6. **Paved area diagram** including drives, parking areas, walks, patios, etc.;
- 4.7. **Drainage and grading plan** if the proposed construction disturbs any dirt or would alter in any manner the flow of storm water or run-off;
- 4.8. **Special features locations**, such as easements, common areas, walls, etc.;
- 4.9. **Utility elements** and improvements, such as utility meters, etc.

Floor Plan. A floor plan must be submitted that details square footage per level and total and showing the roof outline, entry steps, service yard details such as screening and all other architectural features.

Roof Plan. A roof plan must be submitted that indicates roof pitch, an outline of the building walls below, the roof outline, dormers, and any other pertinent features.

Elevation Drawings. Elevation drawings must be submitted to include all four elevations, indicate existing grades and finished grades, exterior finishes of materials, roof pitch, window and door designs, service yard enclosure, screening of meters and equipment and any other pertinent information such as the windscreen for the chimney.

Color and Materials Specifications. Color and materials specification to be used must be identified in the application. If requested by the DRB, samples of both color and materials are to be submitted to the DRB in a form provided by the DRB in their request.

Detail Drawings. Detail drawings must be submitted showing wall sections, service area enclosure details, and other architectural details. A schedule of window types and finish

colors would help in the review process.

Electric Plan. An electric plan must be submitted to show the location of the meter setting, locations and specification and fixtures of exterior lighting including security lighting and other electrical equipment for pools, etc.

Landscape Plan. A landscape plan must be submitted to show the general design plan for site landscaping.

Grading Plan. A grading plan must be submitted indicating drainage plan, any proposed grade changes and proposed erosion control devices.

3.2. Changes After Approval of Final Construction Plans

Any plans or applications altered in any manner from plans or applications initially reviewed by the DRB shall be re-submitted to the DRB for review.

3.3. Construction Guidelines.

3.3.1. GENERAL.

These Construction Guidelines are intended for compliance by all contractors, subcontractors, material suppliers, maintenance personnel and any others engaged in construction or related activity in Trailwoods. These Guidelines are not intended to restrict, penalize or impede construction activity during reasonable performance of duties while within Trailwoods. Rather, they will be enforced fairly to achieve the objectives enumerated below and in the Governing Documents and to facilitate orderly and controlled construction activity, thereby preserving the overall quality of Trailwoods's appearance. Violations are subject to assessments and repeated violations may be cause for denial of access.

3.3.2. GUIDELINES.

1. **Site Clearing.** Site clearing or construction on any property within Trailwoods is not permitted without first submitting application and obtaining final approval from the DRB.
2. **Trash Receptacles.** Each building site must have a trash receptacle for construction debris and is to be emptied or removed when full. When and where appropriate and with approval of the DRB, contractors may coordinate sharing of trash receptacles. The dumping of construction trash is not permitted inside Trailwoods and must be removed by covered truck. Wind-blown trash pickup is required. Any default by an Owner or contractor under this section shall be remedied within 24 hours of notice of such default.
3. **Portable Toilets.** Clean and sanitary conditions are required for all toilets. When and where appropriate and with approval of the DRB, contractors may coordinate sharing of portable toilets. In all respects, the DRB will seek to lessen the aesthetic impact and total number of portable toilets in Trailwoods during construction.
4. **Nuisances.** No loud speakers are permitted on building sites. Inappropriate volume levels on radios, stereos, etc. will not be permitted.
5. **No Pets.** Pets are not allowed on building sites.
6. **Compliance with Design Review Board Approval.** All buildings and landscape plans must be approved in writing by the DRB, and the owner and the building contractor are jointly

responsible that approved plans are followed in all aspects with respect to the exterior of the house and grounds. Construction is to be complete to a point of having the exterior finished and landscaping in place in accordance with the approved plan within twelve (12) months of commencement. Any change to the exterior of the house, siding, driveway, garage, etc., must receive prior approval from the DRB.

7. **Signs.** To minimize visual clutter, the DRB has a job site sign standard to be used on all construction sites. A sign stanchion specification will be provided by DRB. Individual contractors will be responsible for providing a sign stanchion per design specifications. Contact the DRB for placement and coordination.
8. **Erosion Control.** Each owner shall be responsible for the installation and maintenance of all necessary erosion control devices and shall at all times keep erosion control devices in good working order. Any failure of erosion control devices and subsequent clean-up shall be the responsibility of the owner. In the event landscaping is delayed to meet optimal planting seasons, owner shall be responsible for establishing and maintaining turf to minimize erosion. Receipt of a DRB acknowledgement of compliance will depend upon compliance with erosion control provisions. Any default by an Owner or contractor of erosion control pursuant to this section shall be remedied within 24 hours of notice of such default.
9. **Repair to Damaged Property.** Damage or scarring to other property, including, but not limited to, open space, other Units, roads, driveways, sidewalks and/or other improvements whether surface or subsurface will not be permitted. If any such damage occurs, it shall be repaired and/or restored promptly at the expense of the person causing the damage. Upon completion of construction, each contractor shall clean the construction site and repair all property, whether above surface or subsurface, which was damaged, including, but not limited to, restoring grades, planting shrubs and trees as approved or required by the DRB and repairing streets, driveways, pathways, sidewalks, culverts, ditches, signs, lighting, and fencing, etc.
10. **Schedule of Assessments for Violations of the Design Review Guidelines for Trailwoods.** The following is a Schedule of Assessments that will be enforced when a contractor or owner violates the Governing Documents and/or these Design Review Guidelines. The assessments collected will be used for grounds beautification in Common Areas and will not be refunded to the contractor or owner. Assessments will be charges against the Unit and may prevent transfer of the Unit or frustration of construction/permanent financing. Assessments levied by the DRB due to violations may be appealed, in writing, with appropriate justification, to the Chairman of the DRB. The Schedule of Assessments may be amended by the DRB to meet the needs of the Property as development continues. Such amendments shall occur as provided under Section 1.3 to the DRG.

Schedule of Assessments

The Violation	Assessment
▪ Violations of 3.3.2.2 above shall be assessed the actual cost of clean up plus \$100.00.	
▪ Violations of 3.3.2.8 above shall be assessed the actual cost of clean up plus \$100.00.	
▪ Other violations of the Governing Documents, including Design Review Guidelines shall be assessed \$5.00 per day. A notice of violation shall be sent certified mail to the Owner or contractor, and any assessment shall accrue on a daily basis beginning 72 hours after	

the Owner or contractor receives such notice. Otherwise, any assessment shall accrue beginning 72 hours of actual notice of the violation.

4. DESIGN STANDARDS

Specific Design Standards

Orientation. Units must conform to the House and Utility Orientation Plan determined and provided by the DRB. Exceptions to the orientation plan may be granted in the sole discretion of the DRB.

Building size and set back requirements. The minimum square footage of the Unit shall be no less than 850 square feet exclusive of basements, open porches, and garages. Front yard and side yard set backs must conform to City ordinance.

Foundation. The foundation may be exposed.

Material. The principal exterior of any structure shall be at least 50% brick, with the remainder being vinyl or hardboard siding. Any deviation from the above must receive DRB approval prior to installation.

Height. The maximum height for a structure must not exceed City ordinance standards and must receive prior approval from the DRB.

Roofs. All roofs shall be completed using shingles colored weatherwood (gray in color) or the equivalent. The roofs must have a minimum pitch slope of 4 to 12 on the front and back of the structure. Any deviation from the above must receive DRB approval prior to installation. All roofing material shall have a 25-year minimum life.

Roof Accessories and Equipment. DRB approval is required for rooftop equipment and accessories, unless specifically excepted in this paragraph. All rooftop equipment must match roofing colors or be of a color that complements the house and must be placed as inconspicuously as possible. Exposed flashing, gutters and downspouts must be painted to match the fascia and siding of the structure unless otherwise approved by the DRB. No exposed attachment straps will be allowed. DRB approval is not required for skylights having measurements of 3' x 5' or less. Skylights should be placed in locations so as not to detract from the building elevations. Any installed solar energy equipment shall have the appearance of a skylight, shall have a finished trim material or curb, and shall not be visible from the street or Common Area.

Driveways. Asphalt drives and parking areas are not permitted. Driveways and parking areas must be concrete or other hard-surface approved by the DRB. Community recreational amenities and model homes constructed by the Declarant or Builders with written approval from the Declarant are exempt from this provision.

General Design Standards

The general design standards are listed below in alphabetical order according to natural headings. The following list of design standards is presented for your convenience and should not be taken to be an exhaustive or exclusive list of items subject to DRB review. If you have any questions about a particular design standard or applicability to your proposed design, please contact the DRB. Unless otherwise indicated within the specific design standard, each design standard applies to every Unit. None of the following design standards should be read so as to negate making an application or the requirement of an Owner to receive DRB approval prior to

undertaking new construction or a modification.

- 4.1. **Address Numbers.** Approval is not required if numbers are not larger than six (6) inches in height, whether such numbers are affixed on the dwelling or mailbox, or painted on the curb.
- 4.2. **Air conditioners and fans.** Window unit air conditioners and fans are permitted so long as they are not visible from any street, any other Unit, or the Common Areas.
- 4.3. **Awnings.** Any form of awning must receive approval from the DRB prior to installation.
- 4.4. **Birdfeeders.** Seeded or suet birdfeeders are only allowed in private backyards below the top of the fence line. Because there are no seeds in hummingbird feeders, these are allowed on private property without a height limit.
- 4.5. **Chimneys.** Chimneys shall not be installed without prior DRB approval.
- 4.6. **Clotheslines.** Clotheslines are prohibited.
- 4.7. **Decks.** Decks may be constructed in the back yard of a Unit with prior DRB approval. Decks must be constructed of wood or other materials similar to the materials used on the residence, must be painted or stained substantially similar to the residence. The DRB may require the underside of the deck to be screened.
- 4.8. **Dog Houses.** Any dog house shall be located in the back yard of a Unit. Any dog house shall not be larger than 4 feet wide by 4 feet long, and 3 feet tall at the peak of the roof.
- 4.9. **Dog Runs.** Dog runs are not permitted.
- 4.10. **Doors.** Door colors and materials shall remain as originally installed, unless otherwise given prior DRB approval.
- 4.11. **Drainage.** All drainage shall conform to City ordinance and the Trailwoods development drainage plan.
- 4.12. **Driveways and Sidewalks.** The Declarant and Builders have installed standard concrete driveways and sidewalks. Any modification to these must receive prior DRB approval and must meet City ordinance. No driveway or sidewalk visible from any street, any Unit, or the Common Areas shall be painted, stained, or otherwise colored or decorated.
- 4.13. **Fences.** Except as provided below, all fencing shall be constructed of 6 foot dog-eared wood stockade with the smooth surface installed facing out from the Unit. Any fencing facing Common Areas shall be constructed of 4 foot dog-eared wood stockade with every other picket removed and the smooth surface installed facing out from the Unit. The DRB may, in its discretion, allow substantially similar fencing materials upon application. Subject to prior DRB approval, an Owner may attach 4 foot black vinyl chain link fencing to the inside of the four foot wood fencing facing the Common Area. For any corner Unit, no fence shall be constructed closer than twenty-one (21) feet from the street, as measured from the base of the curb to the base of the fence.
- 4.14. **Firewood Storage.** DRB approval is not required provided such storage occurs in the backyard of a Unit, is not visible from any Unit in the vicinity, and does not constitute a nuisance or hazard or breach of the Governing Documents.
- 4.15. **Flags and Flagpoles; Decorations.** Flag poles are permitted provided they do not exceed 20 feet in height and receive prior DRB approval. Any flags of a federal or state nature are allowed. Decorative flags are not discouraged, but will be disallowed if, in the sole discretion of the Board, the decorative flag has a negative affect on the

aesthetic quality of the community. Flags that are obscene, abusive, or that communicate messages repugnant to a reasonable person are disallowed. All holiday and seasonal decorations shall be removed within a reasonable time after the end of such holiday or season.

- 4.16. **Garages and Garage Doors.** Each Unit shall have no more than a 2 car garage. No vehicle storage structure shall be converted to livable quarters. Carports shall not be allowed.
- 4.17. **Gardens. Flower.** No DRB approval required. **Vegetable.** Vegetable gardens are not permitted on Units adjoining Common Areas. DRB approval not required if space has been previously approved under a landscape plan or area is fully contained within a fenced backyard of a Unit. Provided further that no vegetables shall exceed the height of any fence on the Unit, and must be wholly contained within the back yard of the Unit.
- 4.18. **Gazebos.** Gazebos, pool houses, and similar personal recreational structures must receive prior DRB approval.
- 4.19. **Irrigation Systems.** Must receive prior DRB approval and shall not interfere with the development drainage plan, any Unit, or Common Areas.
- 4.20. **Landscaping.** See, Section 5 below.
- 4.21. **Lights and Lighting.** All exterior lighting shall receive prior DRB approval.
- 4.22. **Mailboxes.** Mailboxes and similar structures shall receive prior DRB approval.
- 4.23. **Motion Detector & Security Lighting.** Motion detectors and security lights are permitted with prior DRB approval. Under no circumstance shall security lighting shall shine on any adjoining Unit.
- 4.24. **Outbuildings.** All outbuildings must receive DRB approval prior to installation. No outbuildings shall be permitted on any Unit adjoining a Common Area where such outbuilding would be visible from the Common Area. Any structure not the single residence constructed on a Unit shall receive prior DRB approval. Metal outbuildings are permitted provided they are less than 6 feet tall at the peak of the outbuilding roof and provided no part of the outbuilding is visible from any street, any Unit, or the Common Areas. Outbuildings taller than 6 foot at the peak of its roof are permitted provided such outbuilding is of the same style, material, and size as that depicted in DRG 1.1 through 1.32 attached hereto. All outbuilding roofs must be shingled with the same shingles as installed on the Unit residence and the color of the outbuilding must match the trim color of the Unit residence. All outbuildings shall be located within any City set back ordinance as well as any set back provided by any Governing Document. Each outbuilding shall be properly permitted as required by City ordinance.
- 4.25. **Outdoor Furniture.** Except with prior DRB approval, all outdoor furniture shall be contained wholly within the back yard of a Unit.
- 4.26. **Painting.** Prior DRB approval is required for all painting, including but not limited to structures and garages, of a color other than originally installed by the Declarant or Builder.
- 4.27. **Patios, Patio Covers, Porches, Arbors.** All patios, porches, and the like must receive prior DRB approval.
- 4.28. **Play and Sports Equipment.** Play and sports items and equipment are not permitted on any Unit adjoining Common Area where such items and equipment would

be visible from the Common Area. All play and sports items and equipment must be wholly contained in the backyard to a Unit and may be no higher than 6 feet tall. Basketball backboards and hoops may not be affixed to any portion of the Unit. Portable basketball backboards and hoops may be used in the front yard of a Unit during daylight hours, but shall be stored out of sight otherwise.

4.29. **Pools.** Small, temporary children's-style pools are permitted provided such pools are contained in the backyard of the Unit, are not visible from any Unit in the vicinity, and are emptied when not in use. Above-ground pools are not permitted on any Unit adjacent to the Common Area. In-ground pools are permitted with prior DRB approval.

4.30. **Roofs.** See, specific design guidelines above.

4.31. **Satellite Dishes and Antennas.** No exterior radio antenna, television antenna, or other antenna, satellite dish, or audio or visual reception device of any type shall be placed, erected or maintained on any Unit, except inside a residence or otherwise concealed from view; provided, however, that any such devices may be erected or installed by the Declarant during its sales or construction upon the units; and provided further, however, that these requirements shall not apply to those antenna which are specifically covered by regulations promulgated under the Telecommunications Act of 1996, as amended from time to time. As to antenna which are specifically covered by the Telecommunications Act of 1996, as amended, the DRB shall be empowered to adopt rules and regulations governing the types of antenna that are permissible hereunder and, to the extent permitted by the Telecommunications Act of 1996, as amended, establishing reasonable, non-discriminatory restrictions relating to appearance, safety, location and maintenance.

As provided in the Telecommunications Act of 1996, "Antenna" is defined as follows: (1) an antenna that is designed to receive direct broadcast satellite service including direct-to-home satellite services and is one meter or less in diameter or diagonal measurement; (2) an antenna that is designed to receive video programming services via multipoint distribution services, including multichannel multipoint distribution services, instructional television fixed services, and local multipoint distribution services and is one meter or less in diameter or diagonal measurement; or (3) an antenna that is designed to receive television broadcast signals.

All Antennas are subject to the provisions set forth below:

1. Any Antenna an Owner places on their property must be registered with the DRB within ten (10) days of installation. Owners shall submit a registration drawing detailing how it complies with the guidelines set forth herein.
2. Installation shall be by a qualified person knowledgeable about the proper installation of Antennas.
3. All Antennas must be installed in accordance with the manufacturers' guidelines to insure safe installation, and must also be installed in compliance with all federal, state and local statutes and regulations regarding safety. In addition, a building permit shall be obtained, if required by local ordinance.
4. No Antenna can be over 39 inches in diameter or diagonal measurement, at its largest dimension. Any device larger than one meter (39 inches) in diameter is **strictly**

prohibited.

5. All Antennas must be properly grounded and must be placed a safe distance from any power lines.
6. All Antennas must be located in a side or rear yard location, not visible from any street(s) or any neighboring properties, provided such location does not preclude reception of an acceptable quality signal.
7. All Antennas shall be ground mounted or shall not be installed higher than is absolutely necessary for reception of an acceptable quality signal.
8. All Antennas must be blended with the background upon which they are placed by painting the Antenna the same color as the house or otherwise screening the Antenna from view from any street(s) or adjacent properties with appropriate landscaping or other materials of a reasonable cost.
9. All installations shall be completed so that they do not damage the common areas of the Association or the Unit of any other resident, or void any warranties of the Association or other owners, or in any way impair the integrity of buildings on Common Areas or Units.
10. Owners are responsible for all costs associated with the antenna, including but not limited to costs to:
 - Place (or replace), repair, maintain, and move or remove antennas;
 - Repair damages to the common property, other Units, and any other property damaged by antenna installation, maintenance or use;
 - Reimburse residents or the Association for damages caused by antenna installation, maintenance, or use.
11. Wiring or cabling shall be installed so as to be minimally visible and blend into the material to which it is attached.
12. No Antenna shall be placed in a location where it blocks fire exits, walkways, ingress or egress from an area, fire lanes, fire hoses, fire extinguishers, safety equipment, electrical panels, or other items or areas necessary for the safe operation of the Association or individual units.
13. No Antenna shall be attached to fencing shared between Units or common areas.
14. No Antenna may obstruct a driver's view of an intersection or a street.
15. To the extent that interpretation of these provisions is necessary, such interpretation will be undertaken by the DRB in full compliance with all federal, state and local statutes and regulations, as may be supplemented or amended from time to time.
16. If antennas are installed on property for which the Association has maintenance responsibility, owners retain responsibility for antenna maintenance. Owners must not install antennas in a manner that will increase maintenance costs for the Association or for other Owners. If such damage occurs, owners are responsible for these costs.

If an Antenna needs to be installed in any way that is not consistent with the above-mentioned provisions due to preclusion of an acceptable quality signal, then the homeowner is asked to submit a request for location approval. The Association's approval will then be based on how well the device is screened from the view of both public and private areas. Important Note: Any Antenna/Satellite Dish that is in any way mounted on your house may void applicable warranties.

- 4.32. **Siding.** Any siding must receive prior DRB approval.
- 4.33. **Signs:** Subject to the restriction that no sign shall be located within any Common Area, and except as reserved by the Declarant, the following sign standards shall apply.
- 4.33.1. **Real Estate Signs:** Temporary, non-illuminated, real estate signs indicating the availability for sale, rent, or lease of a specific Unit upon which this sign is erected or displayed are approved without application, provided the sign does not exceed five (5) square feet in total area, does not exceed four feet (4') in height, and the Unit is restricted to one (1) sign per street frontage. Such signs are to be removed immediately following sale closing or rental occupancy of the property. Such signs may not be placed on any fence. Open House signs shall conform to the above dimensions, are limited in number to six (6), shall be placed only upon the owner's Unit or within the public right-of-way for the duration of the open house, and shall not block or interfere with traffic visibility. All signs must also meet local sign codes.
- 4.33.2. **Garage Sale Signs:** A sign advertising the existence of a garage sale of personal property may indicate the date, time and location of the sale. Such signs may have a maximum area of three (3) square feet, and may be posted for the period of the garage sale only. Such signs may not block or interfere with traffic visibility, and shall be posted only on the owner's Unit or within the public right-of-way.
- 4.33.3. **Political Signs.** Signs depicting the name and office of a legitimate political candidate who has filed for a present political race are allowed, provided such signs do not exceed a maximum area of three square feet. Such signs shall be removed the day after elections pertaining to the candidate's race. All signs depicting political slogans and information other than the candidate's name and office shall receive prior DRB approval.
- 4.33.4. **Other Signs.** All other signs, including but not limited to, posters, billboards, advertising devices, or displays of any kind, are not permissible for posting on any Unit without the prior written consent of the DRB.
- 4.34. **Skateboard Ramps.** Not permitted.
- 4.35. **Skylights.** See, specific design standards.
- 4.36. **Solar Devices.** All solar devices must receive prior DRB approval.
- 4.37. **Statues, Sculptures, Fountains, Ponds.** Placement of any statue, sculpture, fountain, pond, or similar artistic expression in the front yard of any Unit or the front and backyard of any Unit adjoining the Common Areas is highly discouraged by the DRB and must receive prior DRB approval. All other locations of artistic expressions visible from other Units or requiring any excavation must receive prior DRB approval.
- 4.38. **Storm/Security Doors.** Storm and security doors are allowed with prior DRB approval.
- 4.39. **Temporary Structures.** Temporary structures suitable for a wedding, birthday party, and similar occasions are permitted in the backyard to any Unit provided such temporary structure is removed within 24 hours of the conclusion of the occasion. This design standard shall not limit Association activities.

- 4.40. **Trash and Garbage Receptacles.** Trash and other receptacles shall be absent from view from any street, any Unit, and Common Areas on all days other than designated trash and/or recycling pick up days.
- 4.41. **Treehouses.** Treehouses constructed in or on vegetation are not permitted.
- 4.42. **Underground Installations.** All underground installations must receive prior DRB approval.
- 4.43. **Walls.** All walls of any nature, for example but not limitation retaining walls, landscaping walls, and decorative walls, must receive prior DRB approval.
- 4.44. **Wells.** Wells of any kind are not permitted.

5. Landscaping Standards

5.1. Overview.

The DRB retains oversight of landscaping improvements to Units to make assurance that the Trailwoods community will continue to be an attractive and pleasant place to reside. The landscape plan will be required for review at the same time the initial site plan is reviewed. The landscaping work shall be completed within nine (9) months of start of vertical construction or within two (2) months of the issuance of the Certificate of Occupancy for the improvements.

5.2. Concepts.

Each Owner should familiarize themselves with these landscape guidelines prior to executing a plan. Each landscape plan should be prepared according to the following criteria:

1. Provide landscaping to enhance the beauty of the Unit and improvements while providing continuity between the Unit, improvements, and surrounding vegetation.
2. Minimize the visual intrusion of the built environment by mitigating areas disturbed during construction.

5.3. Objectives.

All Units, after construction, require landscaping. The design of the landscaping will vary, depending on size, shape, topography, and location of the property and the design of the structure. It is the intent of the landscaping to accomplish the following objectives:

1. **Beautify.**
 - 1.1. Soften vertical structure from the horizontal ground plane, with foundation plantings of sufficient density and size to break the line between ground plane and structure.
 - 1.2. Soften the impact of corners and broad wall areas with vertical and spreading foliage.
 - 1.3. To soften and reduce apparent height of house, foundation planting at the front should be layered from the ground plane using small plants towards the front and then transitioning up to larger plants near the foundation. A single row of uniformly spaced plants of equal size arranged in a single row along the foundation is not acceptable. Installing plant material of different sizes and textures in natural groupings is a preferred alternative.
2. **Screen.** Visually screen compressors, tanks, service yards, transformers, telephone pedestals, recreation equipment, parking, driveways, patios and other hard or unsightly areas.
3. **Restoration.** Restoration of a site due to construction.
4. **Drainage.** It is the responsibility of each owner to handle surface water on the Unit to

minimize impact on adjoining property and insure that water is moved to the appropriate areas to interface properly with Trailwoods's master drainage plan.

5. **Phasing.** This approach to landscaping is approvable; however, the initial phase must meet the first four (4) objectives above.
6. **Conservation.** Owners are also encouraged to plan for the conservation of water by planting native and drought resistant species.
7. **View.** Taller plantings and recreation equipment should not be placed in the neighbor's view line. Existing vegetation will be allowed to remain in the view line. The view line is defined by staffing at the left and right rear property corners and proceeding twenty (20) feet toward the front corners and twenty (20) feet toward the center across the rear property line. These two new points, near each corner, when connected form triangles that should remain free of obstructions for neighbor's view corridors.

5.4. Plans.

1. **Landscaping.** The landscaping plan must be professionally prepared on a site plan indicating topography, existing and proposed vegetation. The plan should be drawn at a scale of 1/8 inch equals one foot. The plan should graphically illustrate location, Unit number, adjoining Unit border lines, nearest structure lines on adjoining Units, sizes of plant material, lawn, mulched areas, and open areas. A schedule must be included on the planting plan indicating the following specifications for each plant: Common name, Plant height at time of planting (2 gallon minimum), Plant quantities, Identify grass and mulched areas.
2. **Identify Trees.** Existing trees of 3" diameter or greater at 48" from the ground, must be identified as to exact location, size of trunk, genus name, and where possible, the species. No existing trees shall be cut, removed, transplanted or damaged without approval by DRB.
3. **Features and Surface.** All existing site features such as roads, walks, structures on adjoining Units, bike paths, walls, etc. are to be graphically noted on the Landscape Site Plan. All surfacing materials are to be noted (as to whether they are concrete, grass, planting beds, etc.). Texturing or other surface treatment of concrete paving is to be indicated and should include color presentation.
4. **Sod Requirement.** All lawn areas must be covered with sod, seed, or other material approved by the DRB.
5. **Tree Requirement.** Trees and shrubs must be planted in accordance with the approved plan within the time frame outlined in Section 5.1.
6. **Irrigation.** Should any Unit have any form of irrigation system installed to irrigate planting beds or grassed areas of the Unit, the spray from such irrigation system should be contained to the Unit. The DRB may require relocation or redirection of spray if adjacent Units, streets or other areas are affected. The DRB is not responsible for the system's performance or function. The DRB shall not be held liable for any injury, damages or loss arising out of the manner or quality of approved irrigation systems.

10' Marco Series Gable Building

Engineering Building
Plans

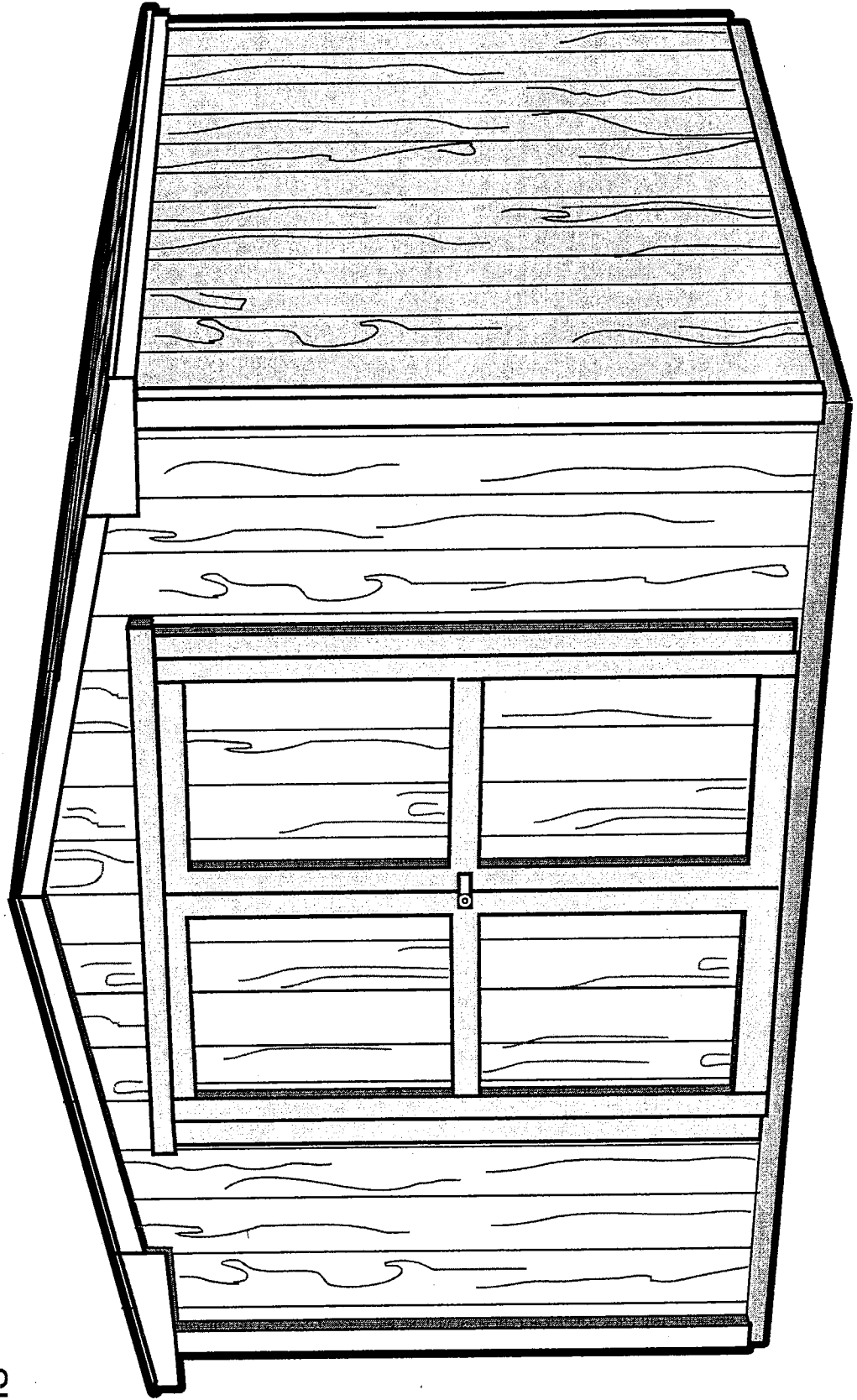

10'x12'

Slab size is 10' x 11' 8-5/8"

10'x16'

Slab size is 10' x 15' 8-5/8"

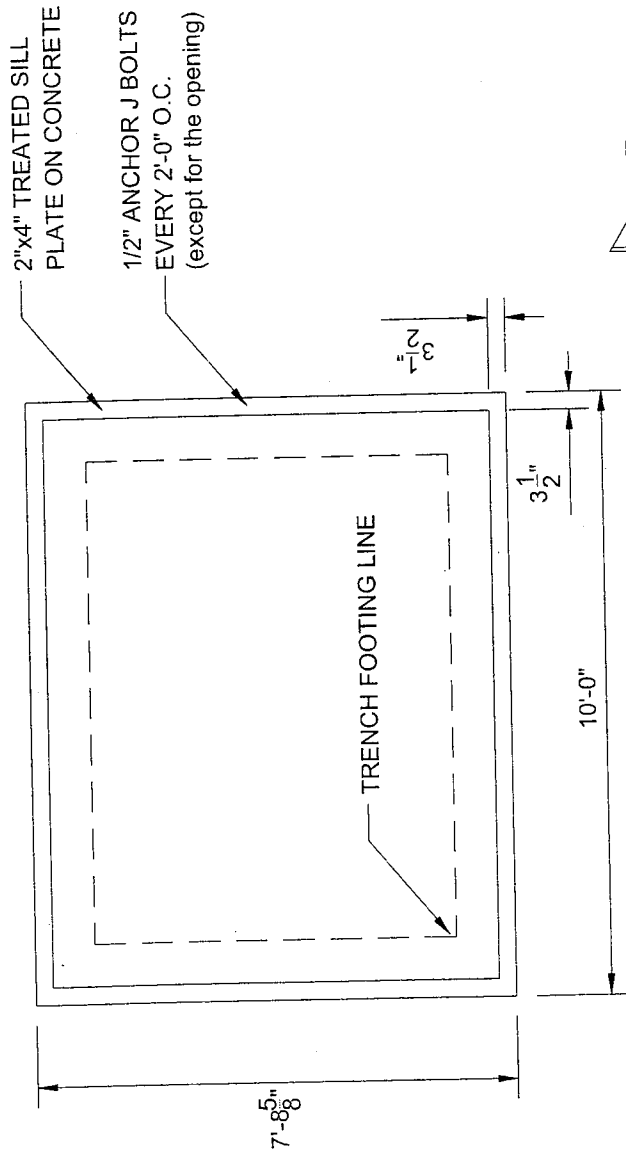

SLAB LAYOUT

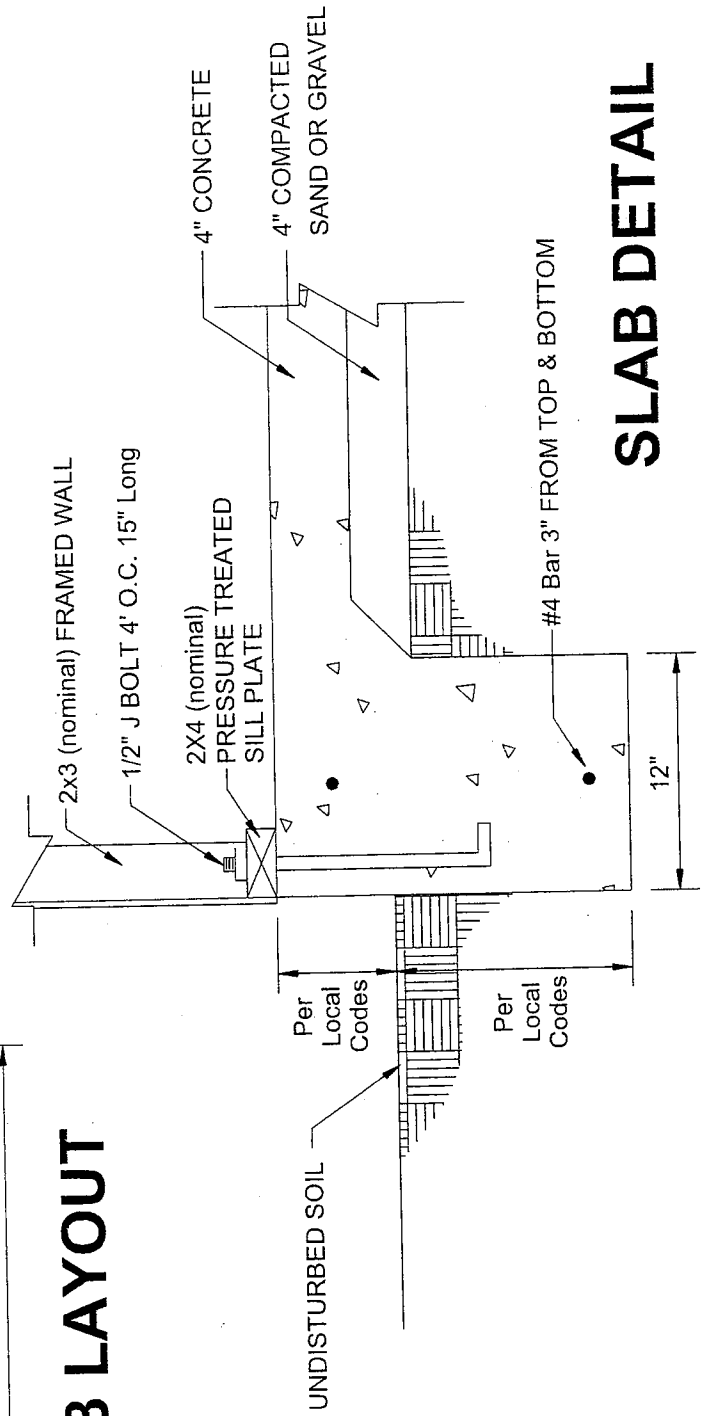

SLAB DETAIL

NOTE:

1.) ONLY THE PIERS INDICATED WITH SP ARE REQUIRED TO HAVE SIMPSON STRONG TIES

10'x12'

Wood Floor size is 10' x 11' 8-5/8"

10'x16'

Wood Floor size is 10' x 15' 8-5/8"

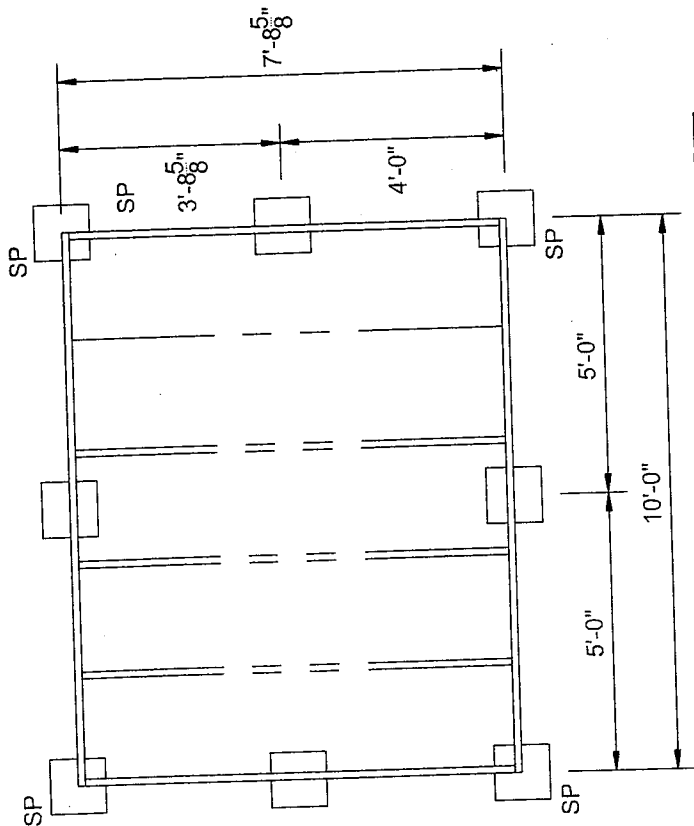

WOOD FLOOR LAYOUT

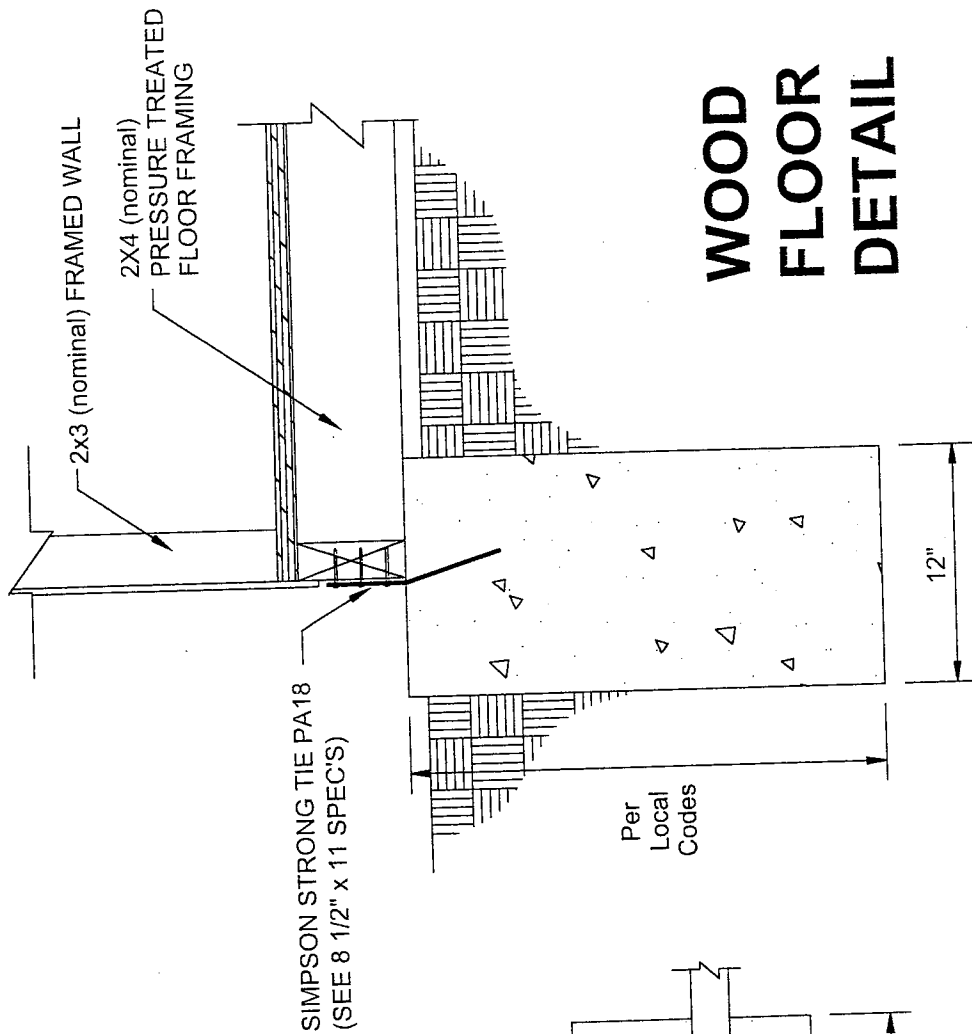

SIMPSON STRONG TIE PA18
(SEE 8 1/2" x 11 SPEC'S)

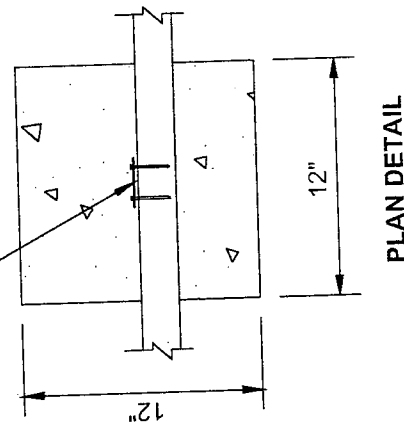

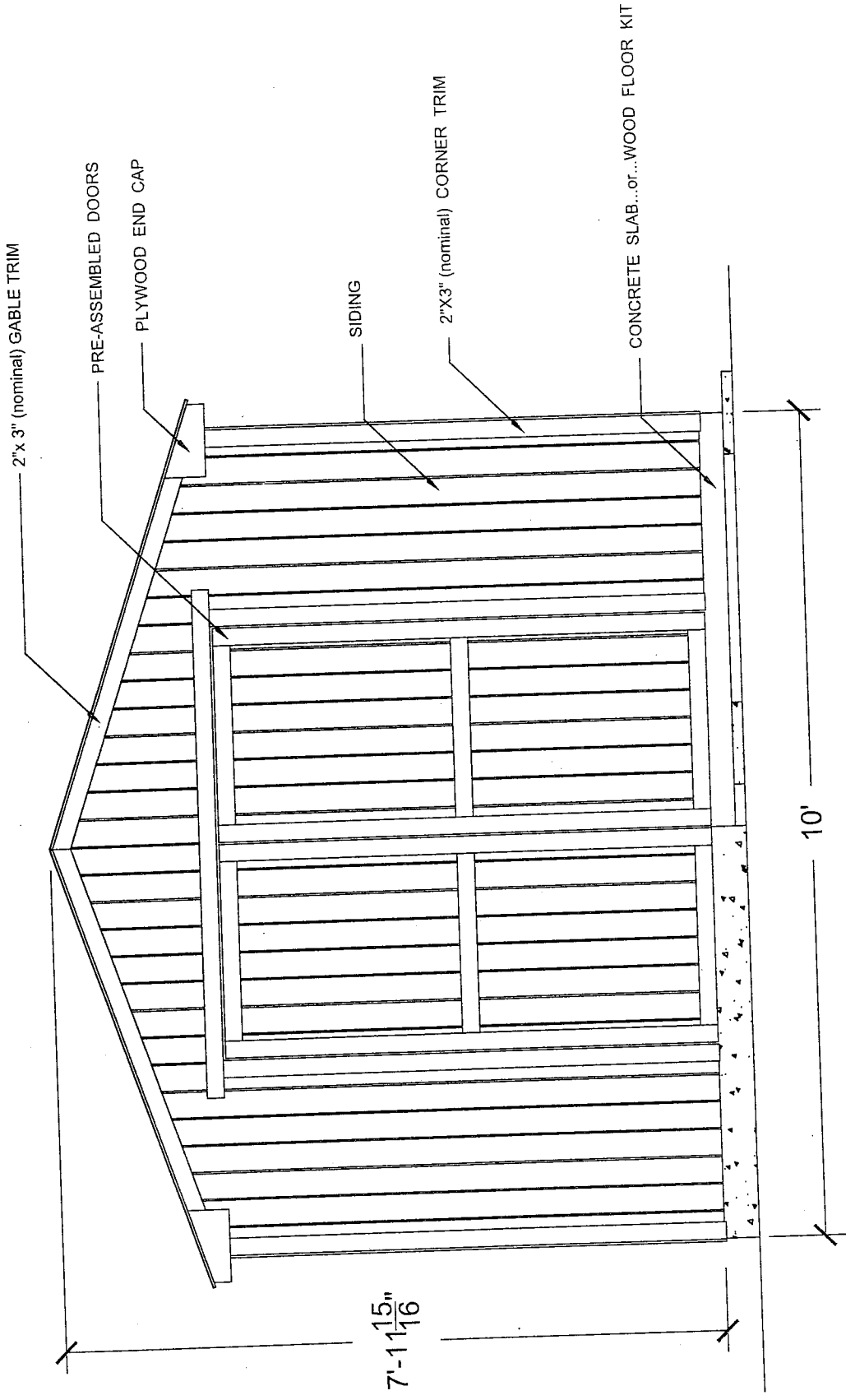

FRONT ELEVATION

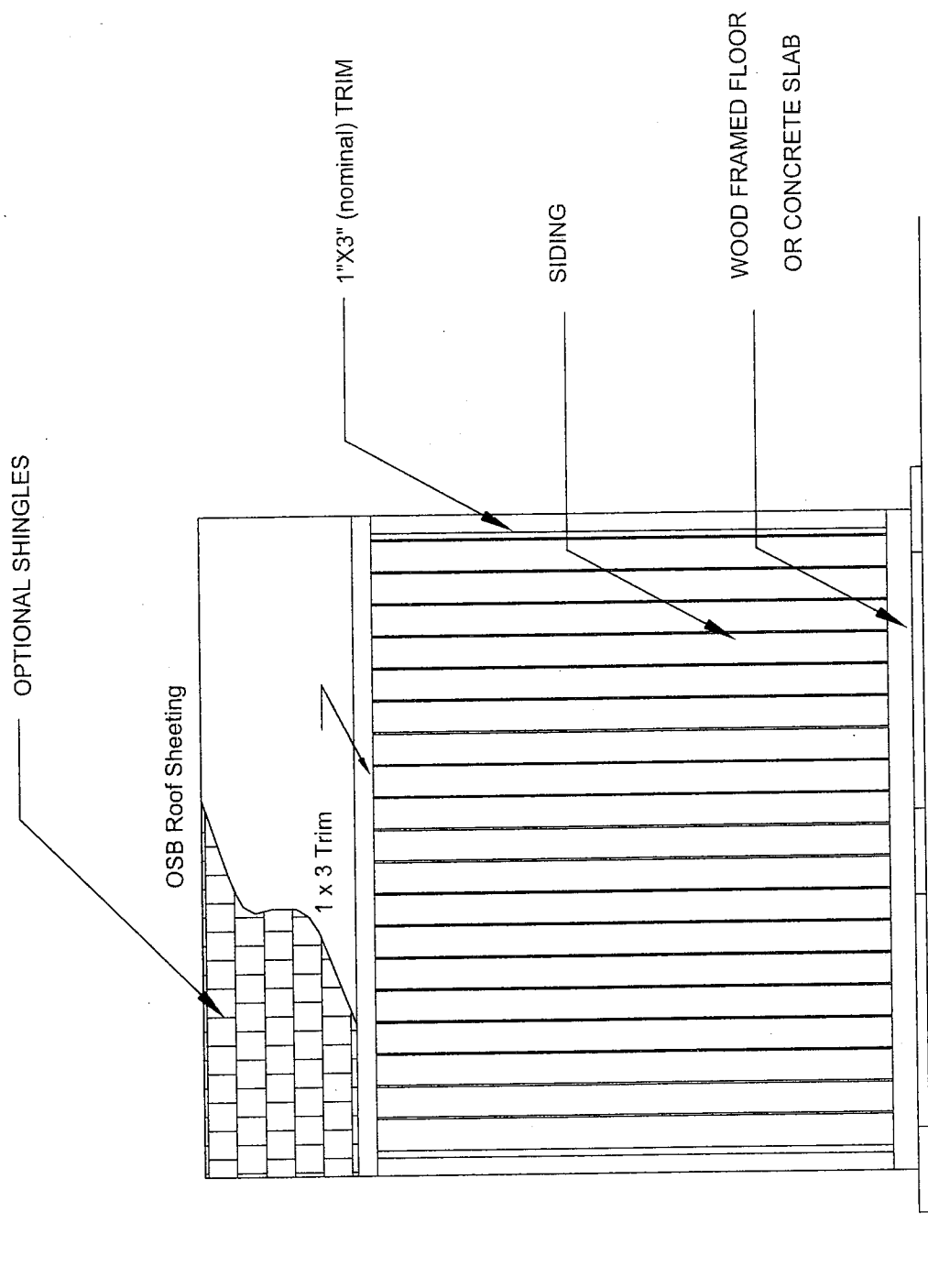

LEFT ELEVATION

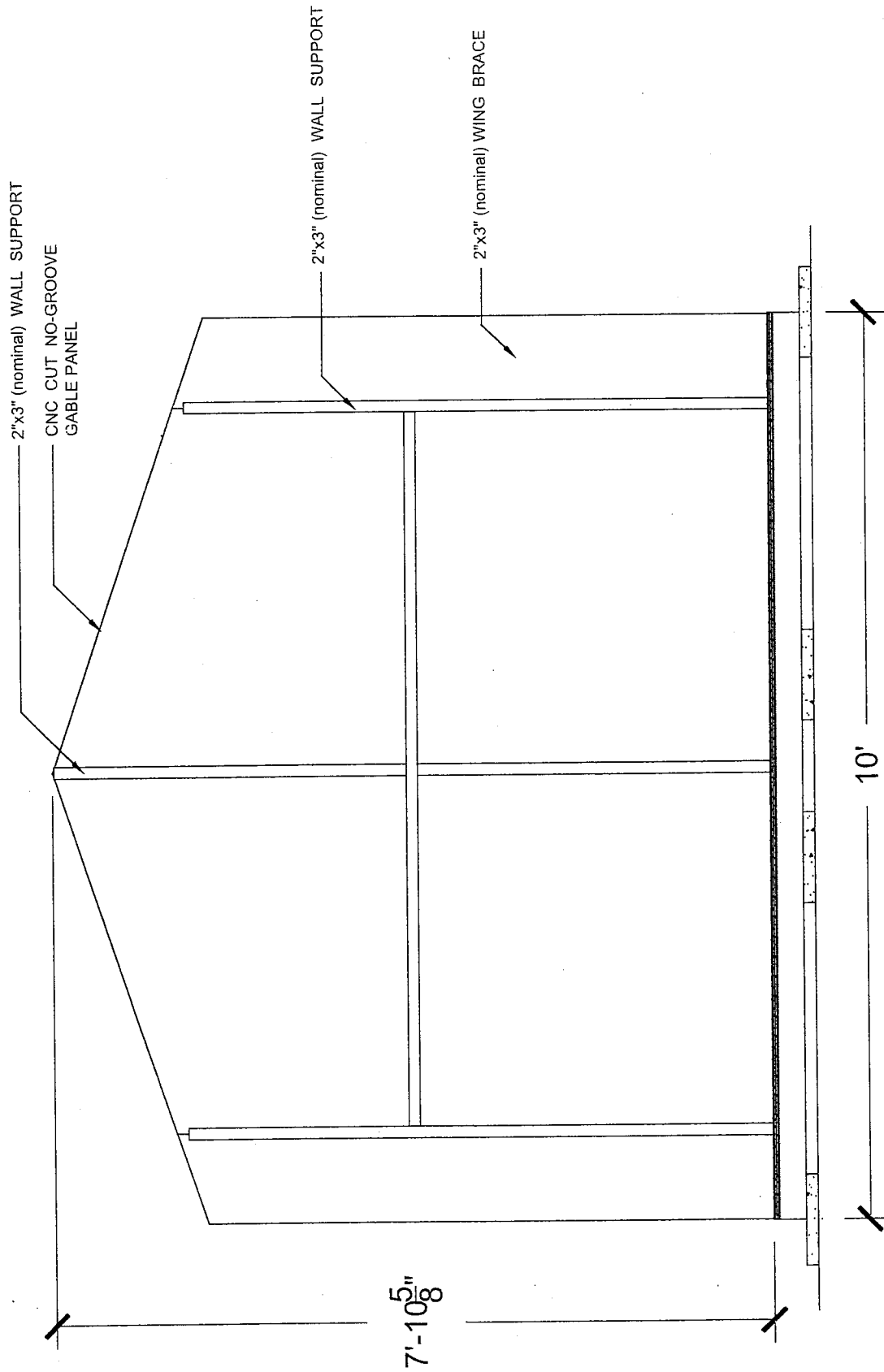

BACK WALL FRAMING

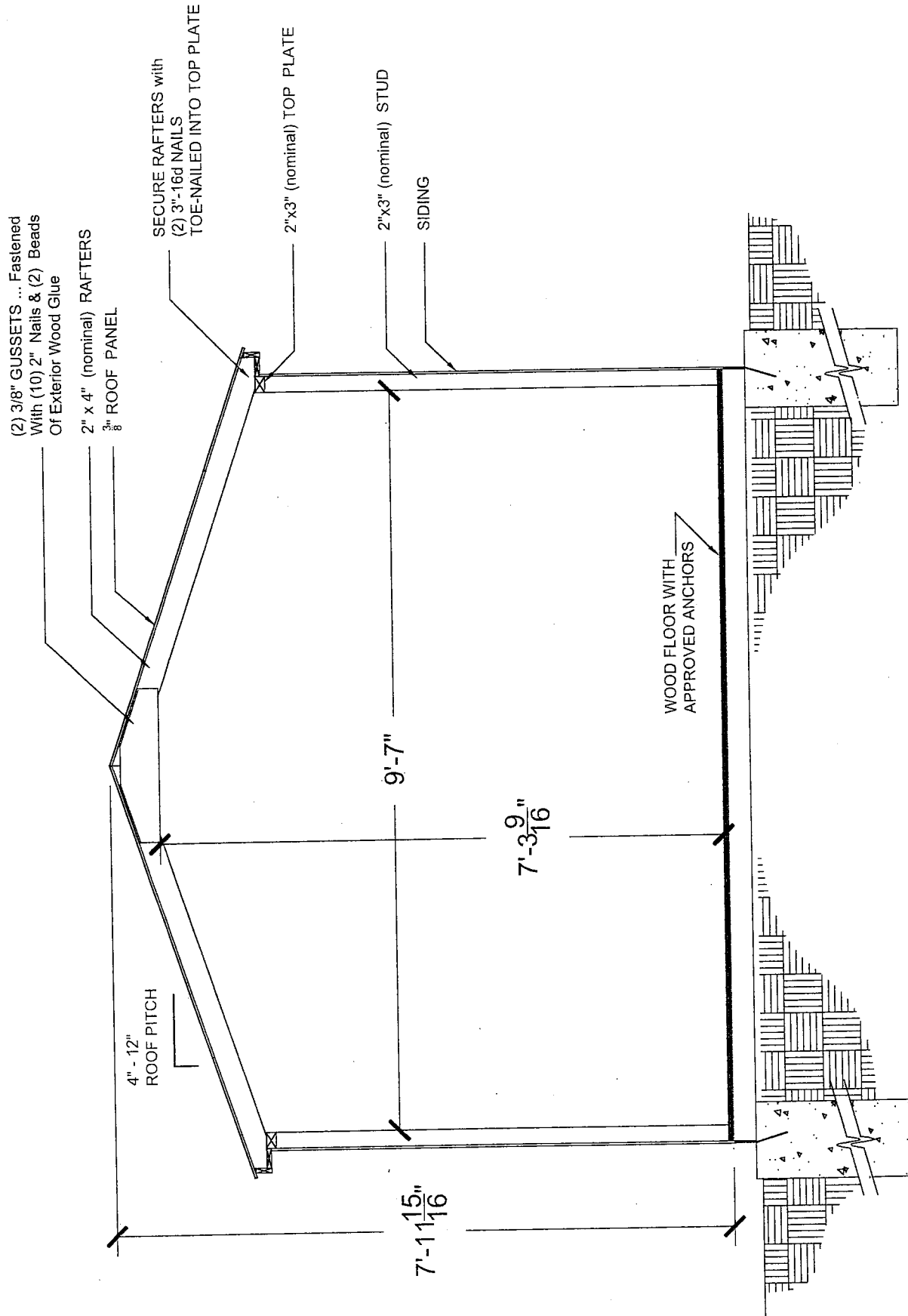

SECTION DETAIL

10' Marco Series Gambrel Building

Engineering Building
Plans for 10x8, 10x12 and 10x16

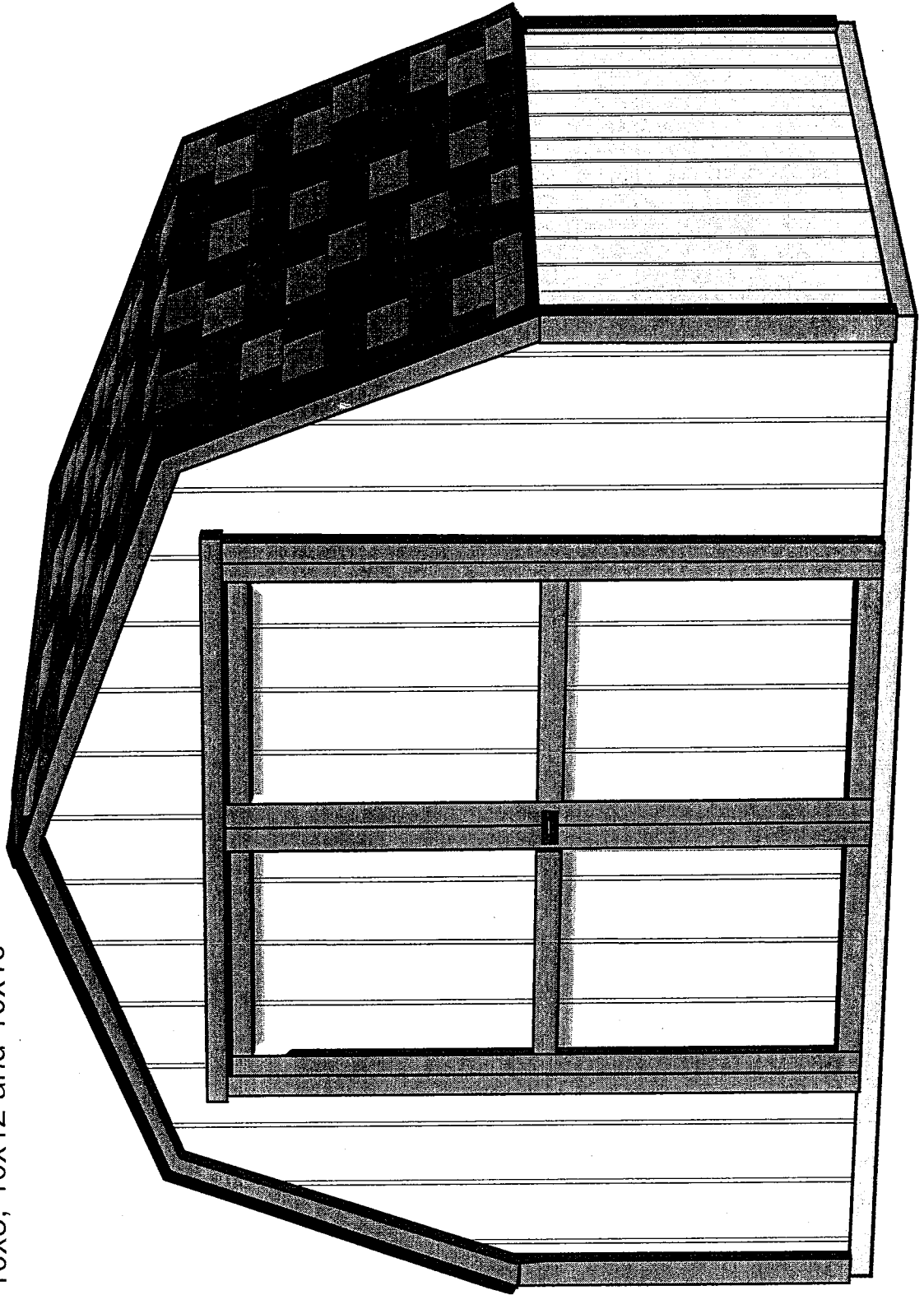

- NOTES: 1) The Roof System of this 10 ft. wide Gable style building has a live load capacity of 45 PSF. The equivalent ground snow load per ANCE 7-98 is 88 PSF which exceeds the 17.3 PSF pressure for a 110 mph wind per ASCE 7-98.
- 2) This plan supplements assembly instructions prepared by Handy Home Products.

STRUCTURAL ANALYSIS:

f b = 1200 PSC
 f v = 80 psi
 Sx 2"x3" = 1.56 in Area = 3.75 in
 Dead Load = 4 PSF (Roof)
 Max Rafter Moment = fb Sx/12=306 ft.lb.
 Max Rafter Shear = 80x3.75=300 lb.
 Max Stud Moment = 156 ft. lb.

WALL SYSTEM:

1) Studs 2x3@24"cc L=3.3ft. w=8M/L2=114PLF=57 PSF
 2) Wind Loading V = 110 mph EXP 1
 Kz=0.37 Gh=1.65 GCpl=-0.25
 I=0.95 Cp=0.8
 Velocity Pressure=8z=.00256Kz(IV) = 10.3PSF
 Design Pressure=P=qfGhCp-(qhGCpl)=16.2PSF
 ok<57PSF

ROOF SYSTEM:

1) Rafters 2x4@2'cc w=8M/L2 = 76PLF=45 PSF-4
 2) Rafter Shear w=2V/L = 117 PLF=92 PSF-4
 3) Sheathing w=45PSF-4=45psf
 4) Ground Snow Load: Ref ASCE 7-98
 Ps=45PSF I=0.8
 Cs=0.95 Ce=0.8
 Ct=1.2 Pf=45/0.95=47.4PSF
 Pg=PF/1.7CeCtI=88 PSF Ground Snow Capacity

10'x12'

Slab size is 10' x 11' 8-5/8"

10'x16'

Slab size is 10' x 15' 8-5/8"

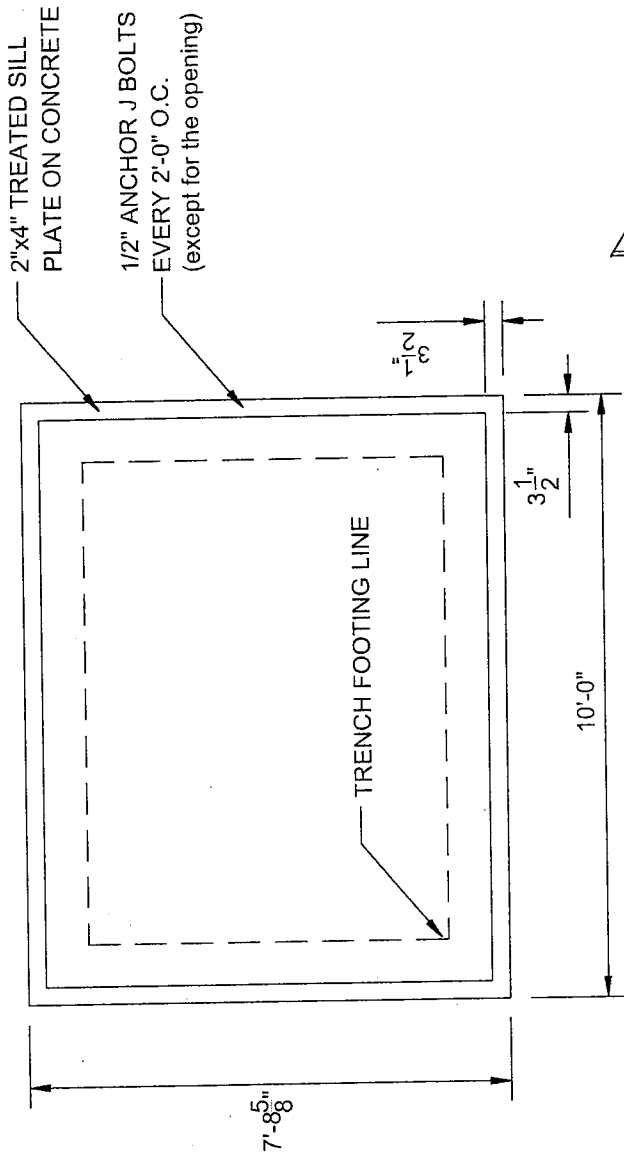

SLAB LAYOUT

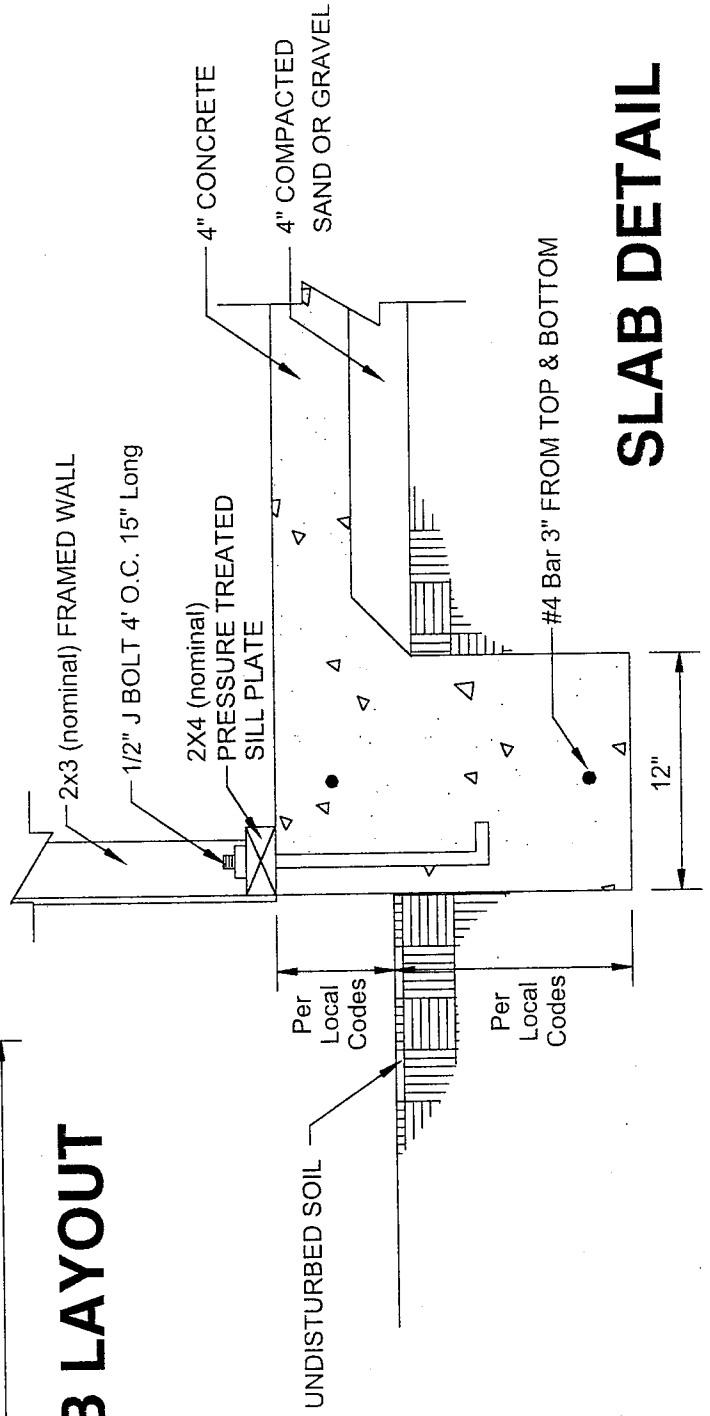

SLAB DETAIL

NOTE:
 1.) ONLY THE PIERS INDICATED WITH SP ARE
 REQUIRED TO HAVE SIMPSON STRONG TIES

10'x12'

Wood Floor size is 10' x 11' 8-5/8"

10'x16'

Wood Floor size is 10' x 15' 8-5/8"

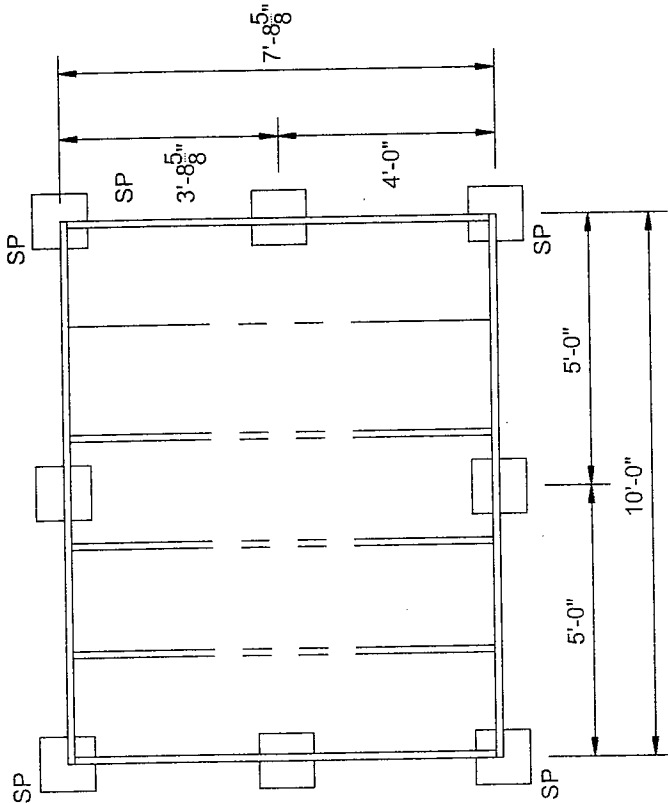

WOOD FLOOR LAYOUT

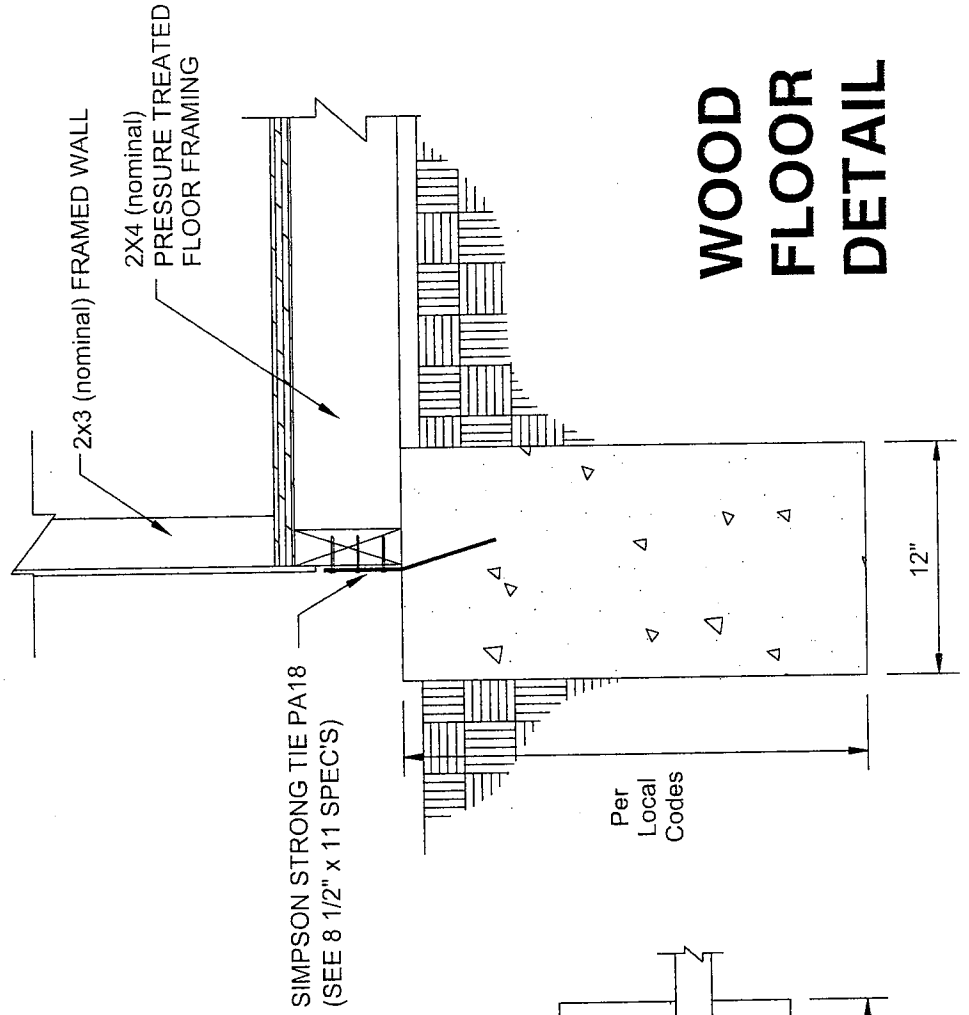

WOOD FLOOR DETAIL

SIMPSON STRONG TIE PA18
 (SEE 8 1/2" x 11 SPECS)

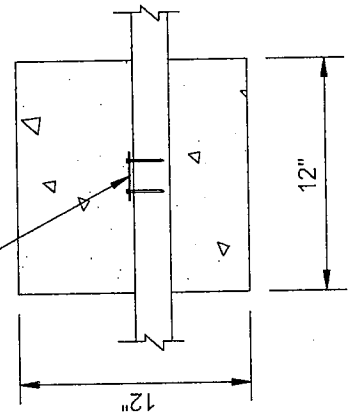

PLAN DETAIL

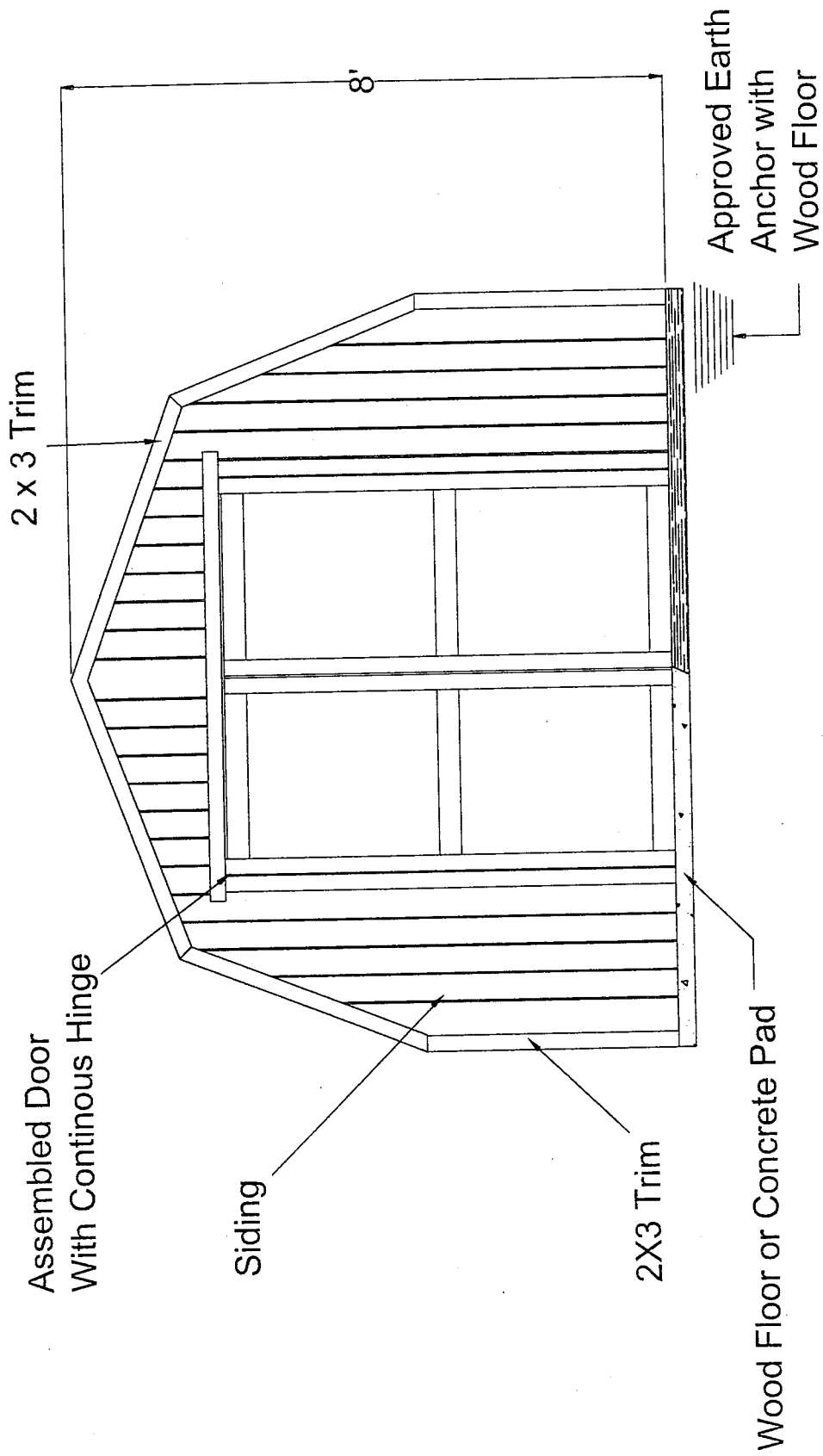

FRONT ELEVATION

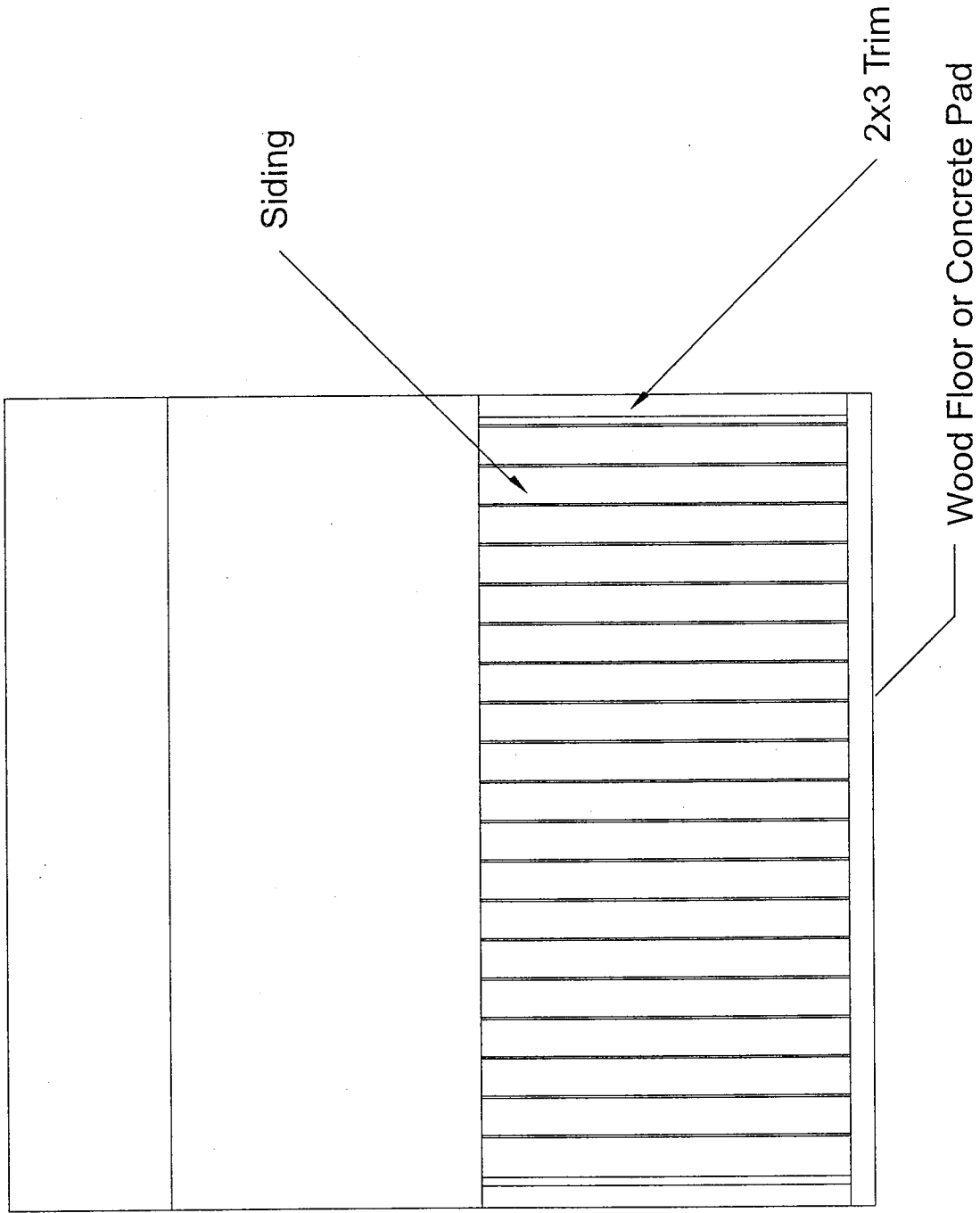

LEFT SIDE ELEVATION

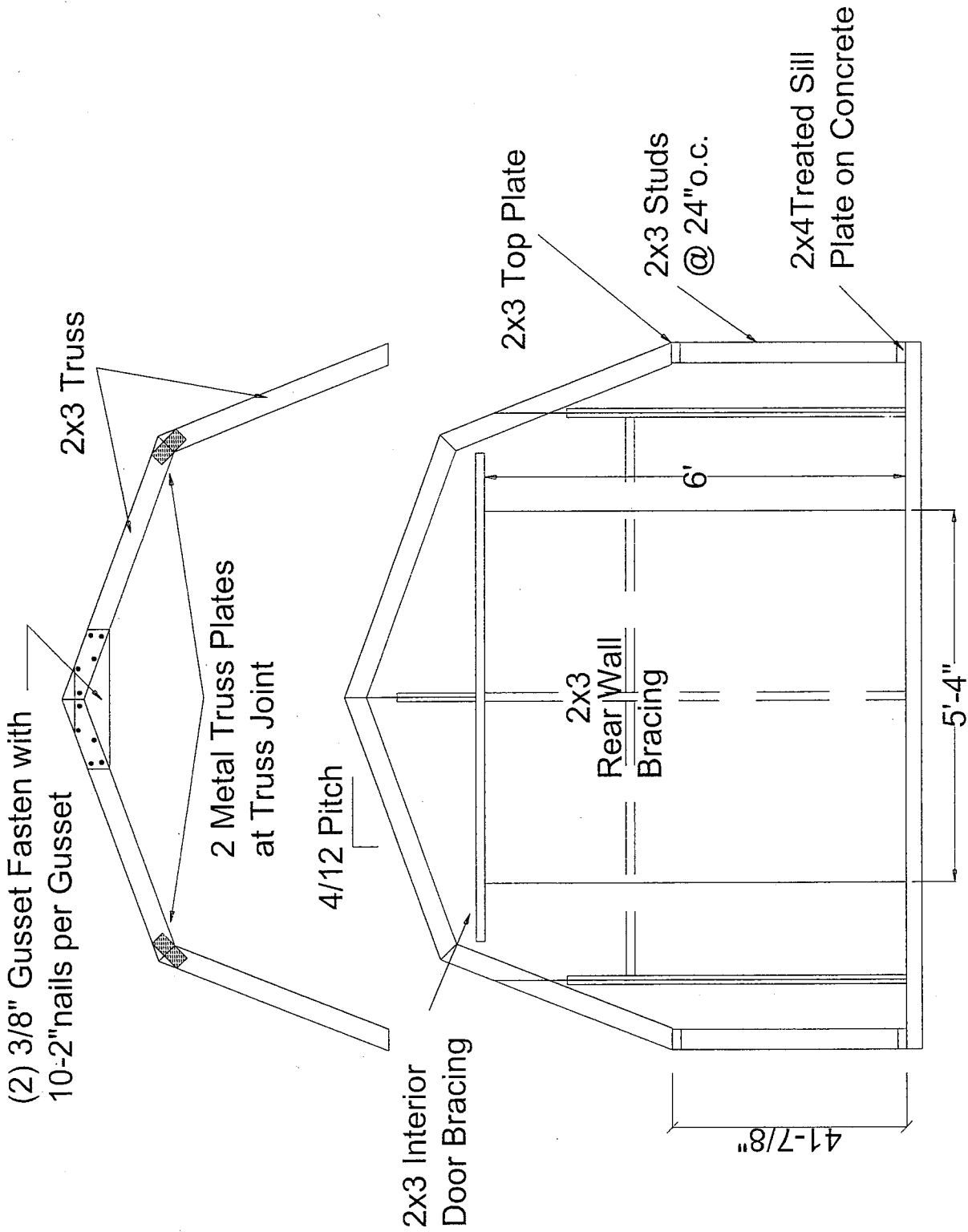

FRONT/REAR WALL FRAMING

O.S.B.
Roof Decking

2X4 Rafters
24" o.c.

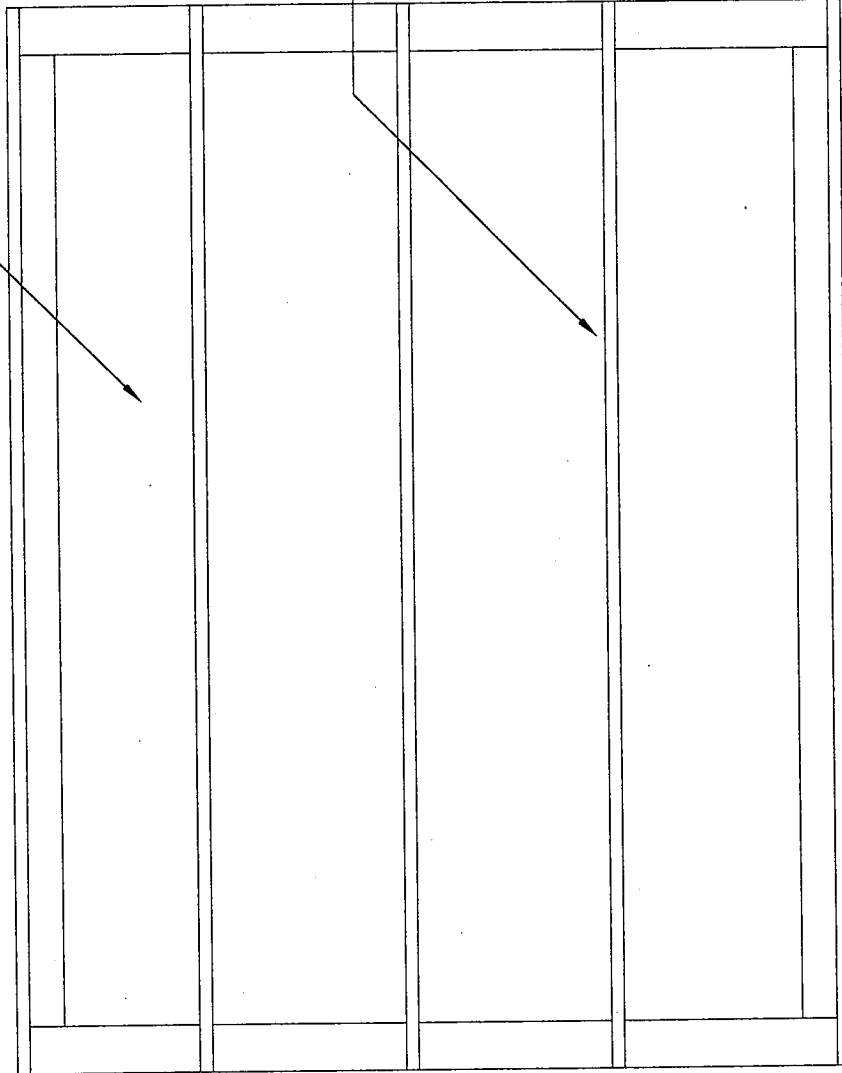

ROOF FRAMING

NOTES: 1) The Roof System of this 10 ft. wide Gabrel style building has a live load capacity of 35 PSF. The equivalent ground snow load per ANCE 7-97 is 68 PSF which exceeds the 16.2 PSF pressure for a 110 mph wind per ASCE 7-97.

- 2) This plan supplements assembly instructions prepared by Handy Home Products.
- 3) Kits for extending the building in 4 ft. increments are identical in construction to the basic building.

STRUCTURAL ANALYSIS:

$f_b = 1200$ PSC

$f_v = 80$ psi

$S_x 2"x3" = 1.56$ in Area = 3.75 in

DEAD LOAD:

Max Rafter Moment = $f_b S_x/12 = 156$ ft.lb.

Max Rafter Shear = $80 \times 3.75 = 300$ lb.

Max Stud Moment = 156 ft. lb.

WALL SYSTEM:

1) Studs $2 \times 3 @ 24"$ cc $L = 3.3$ ft. $w = 8M/L^2 = 114$ PLF = 57 PSF

2) Wind Loading $V = 110$ mph EXP 1

$K_z = 0.37$ $G_h = 1.65$ $G_{Cpl} = -0.25$

$I = 0.95$ $C_p = 0.8$

Velocity Pressure = $8z = .00256 K_z(IV) = 10.3$ PSF

Design Pressure = $P = qfG_h C_p - (qhG_{Cpl}) = 16.2$ PSF

ok < 57 PSF

ROOF SYSTEM:

1) Rafters $2 \times 3 @ 2'$ cc $w = 8M/L^2 = 78$ PLF = 39 PSF-4

2) Rafter Shear $w = 2V/L = 150$ PLF = 75 PSF-4

3) Sheathing $w = 49$ PSF-4 = 45 psf

4) Ground Snow Load: Ref ASCE 7-97

$P_s = 35$ PSF $I = 0.8$

$C_s = 0.95$ $C_e = 0.8$

$C_t = 1.2$ $P_f = 35/0.95 = 36$ PSF

$P_g = P_f / 7 C_e C_t I = 68$ PSF Ground Snow Capacity

8' Marco Series Gambrel Building

Engineering Building
Plans for 8x8

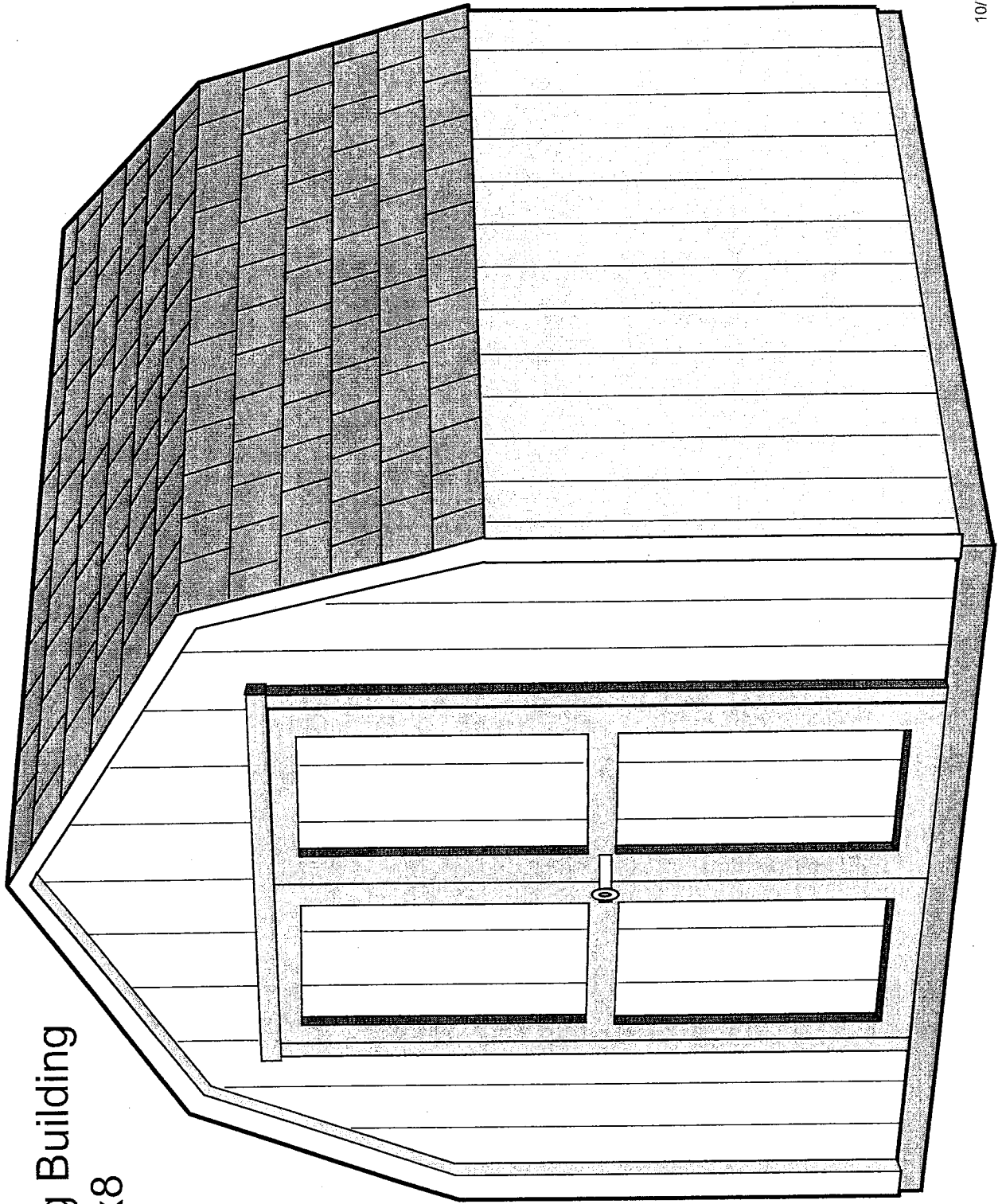

10/7/03

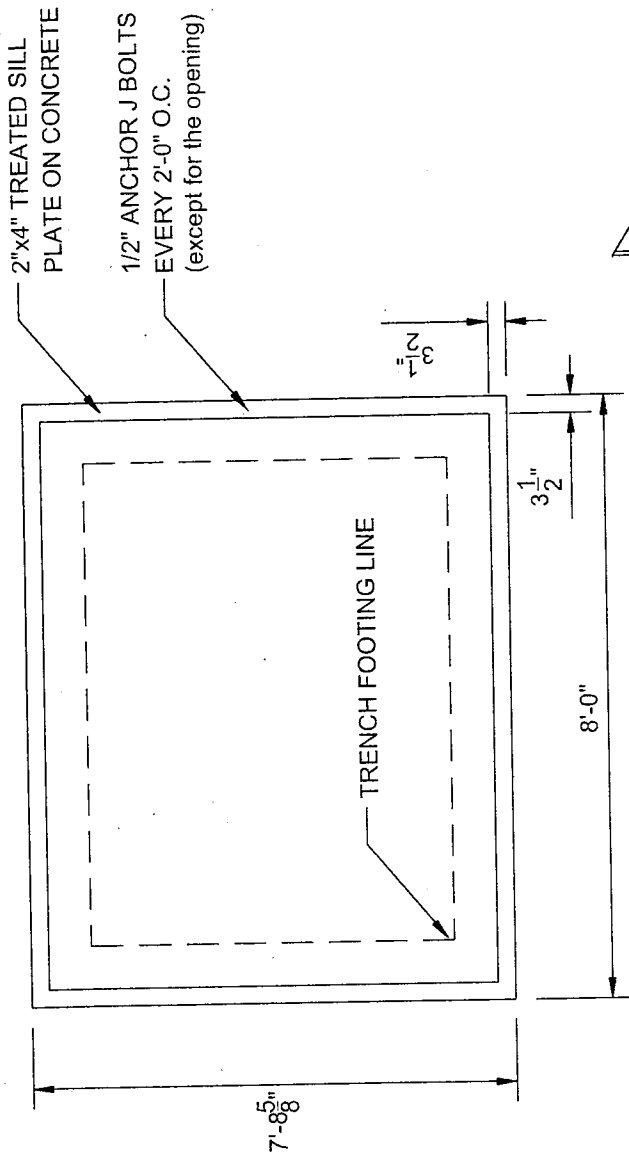

SLAB LAYOUT

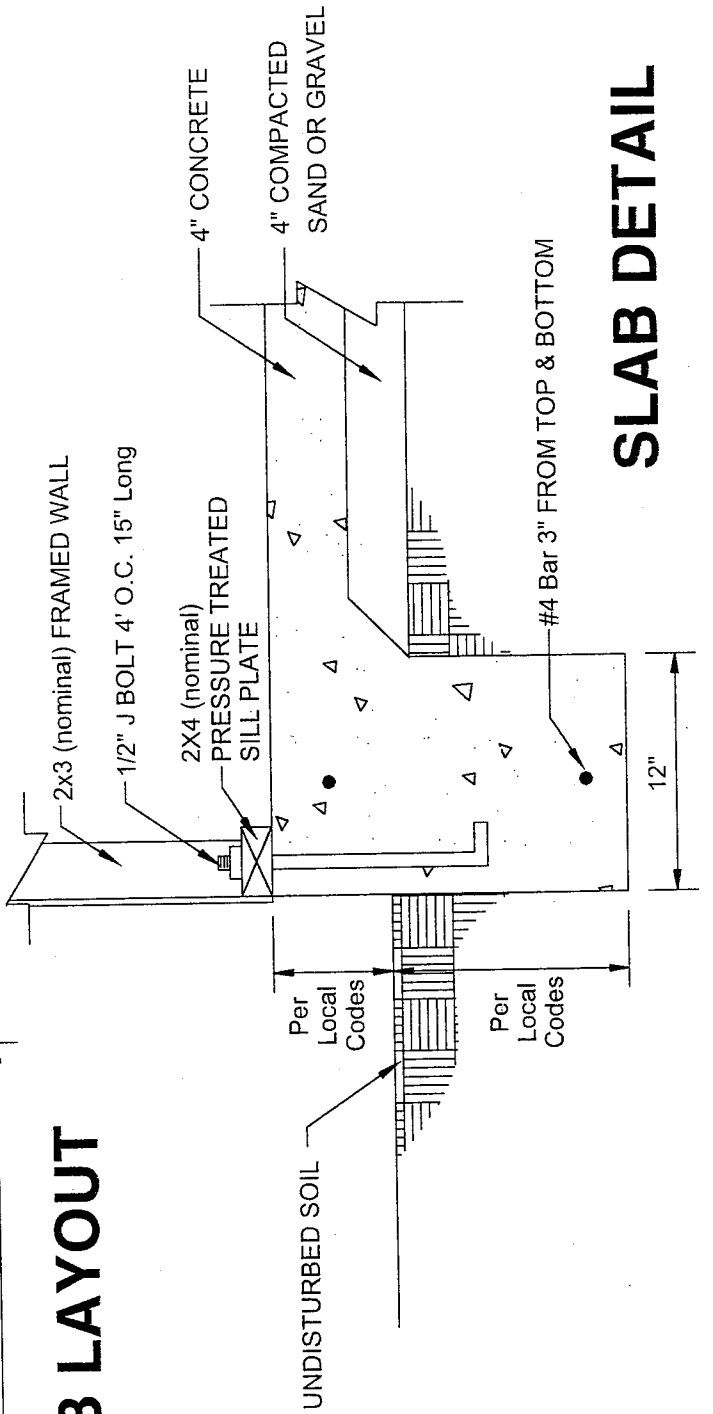

SLAB DETAIL

NOTE:
 1.) ONLY THE PIERS INDICATED WITH SP ARE
 REQUIRED TO HAVE SIMPSON STRONG TIES

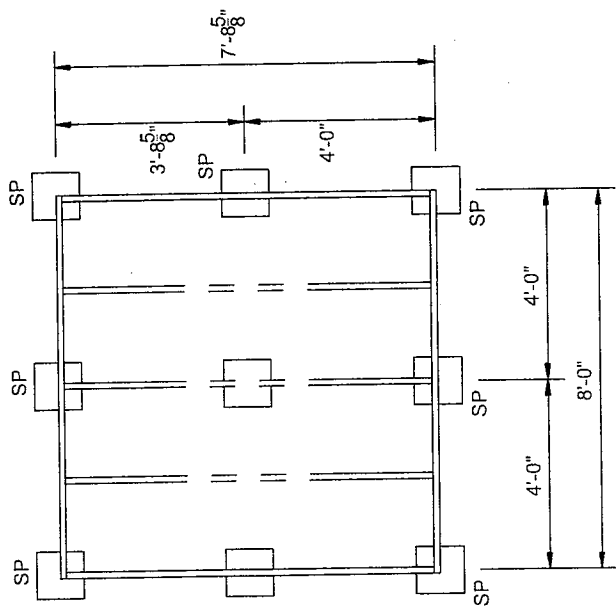

WOOD FLOOR LAYOUT

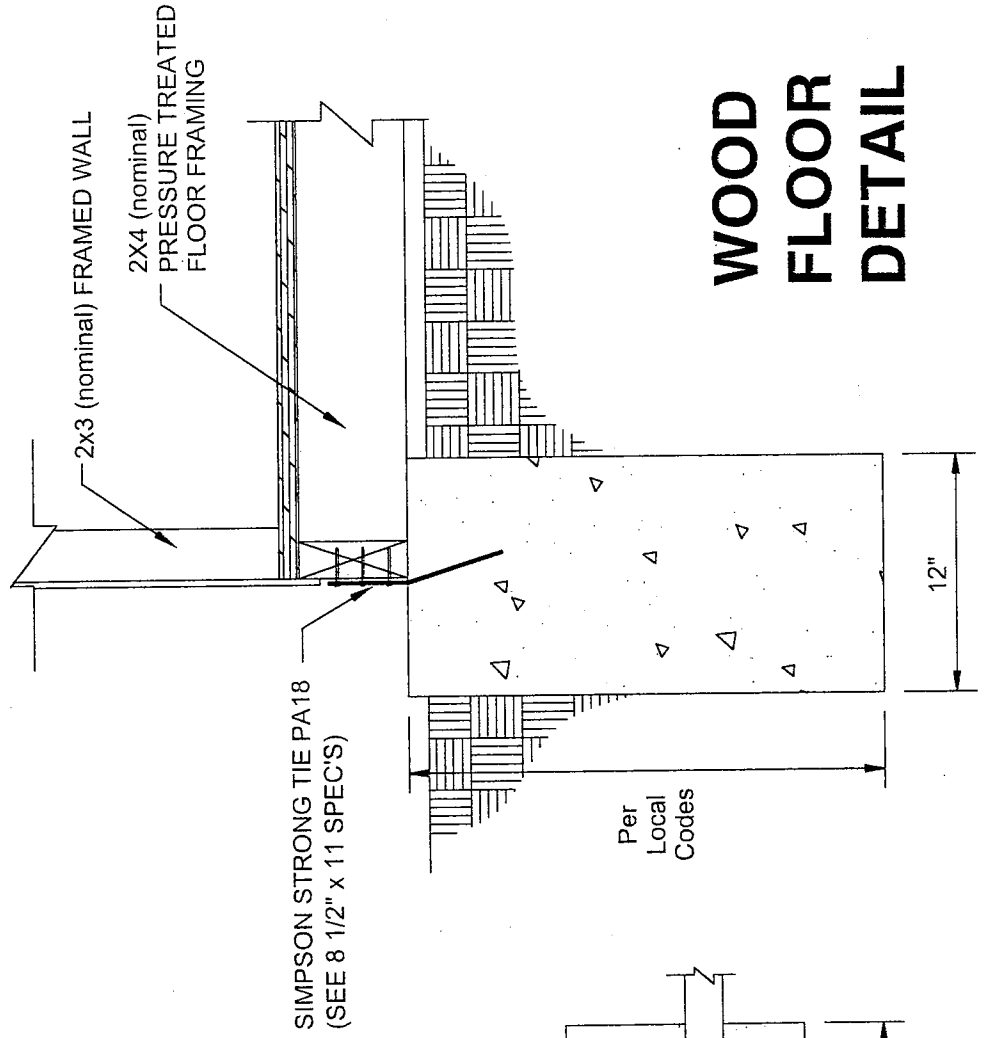

WOOD FLOOR DETAIL

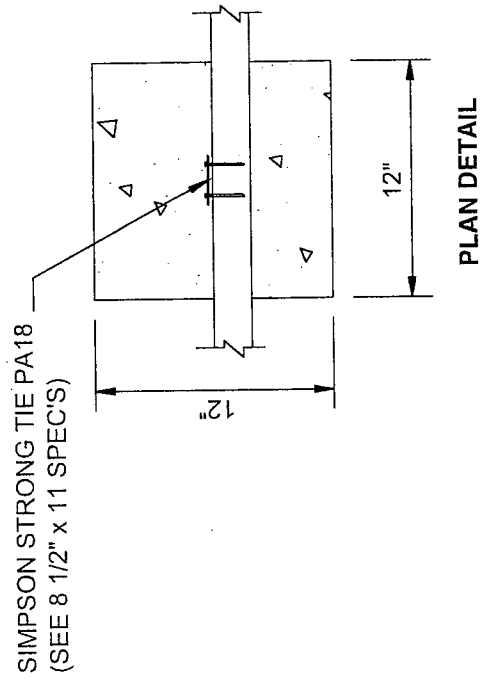

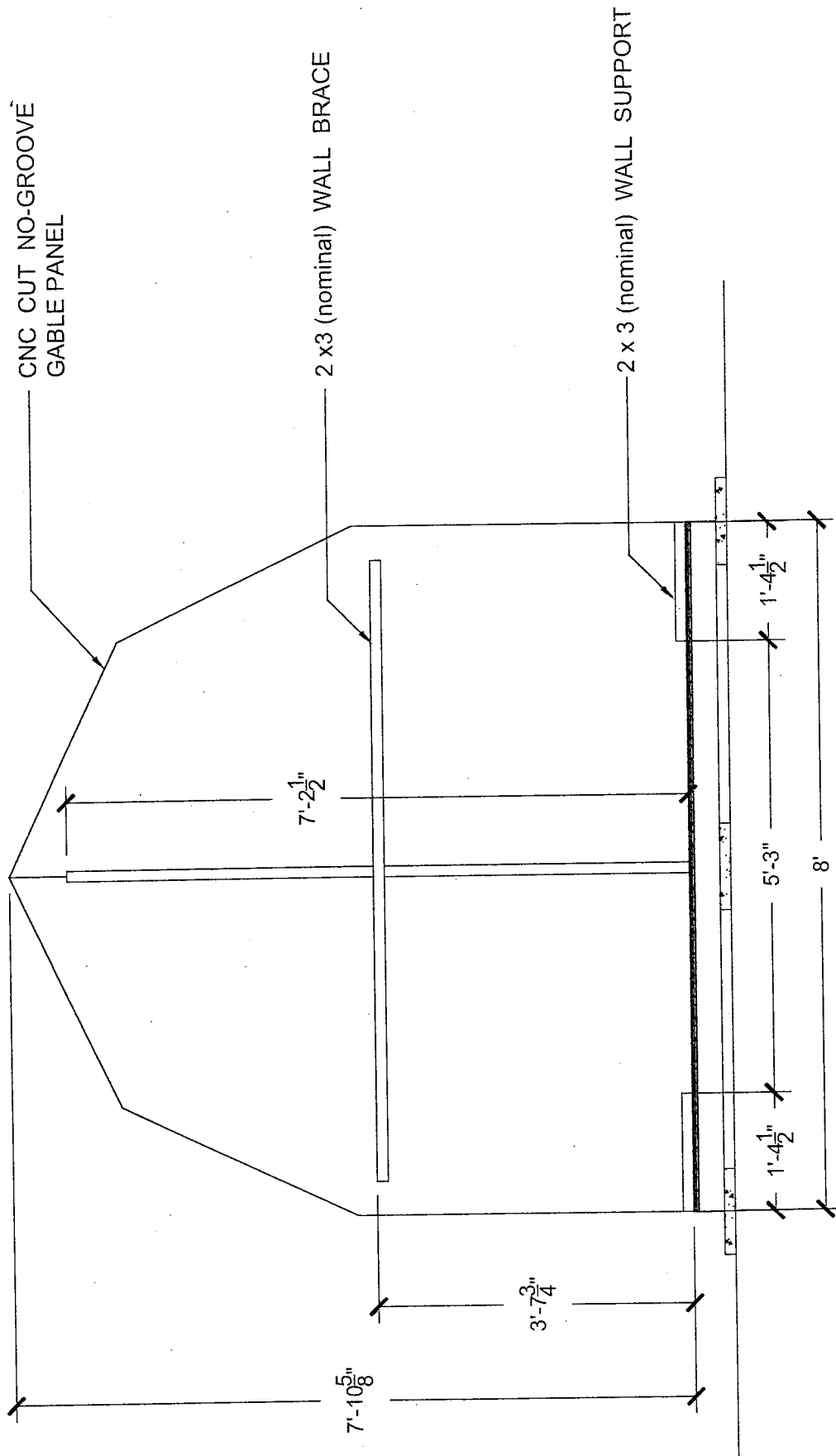

BACK WALL FRAMING

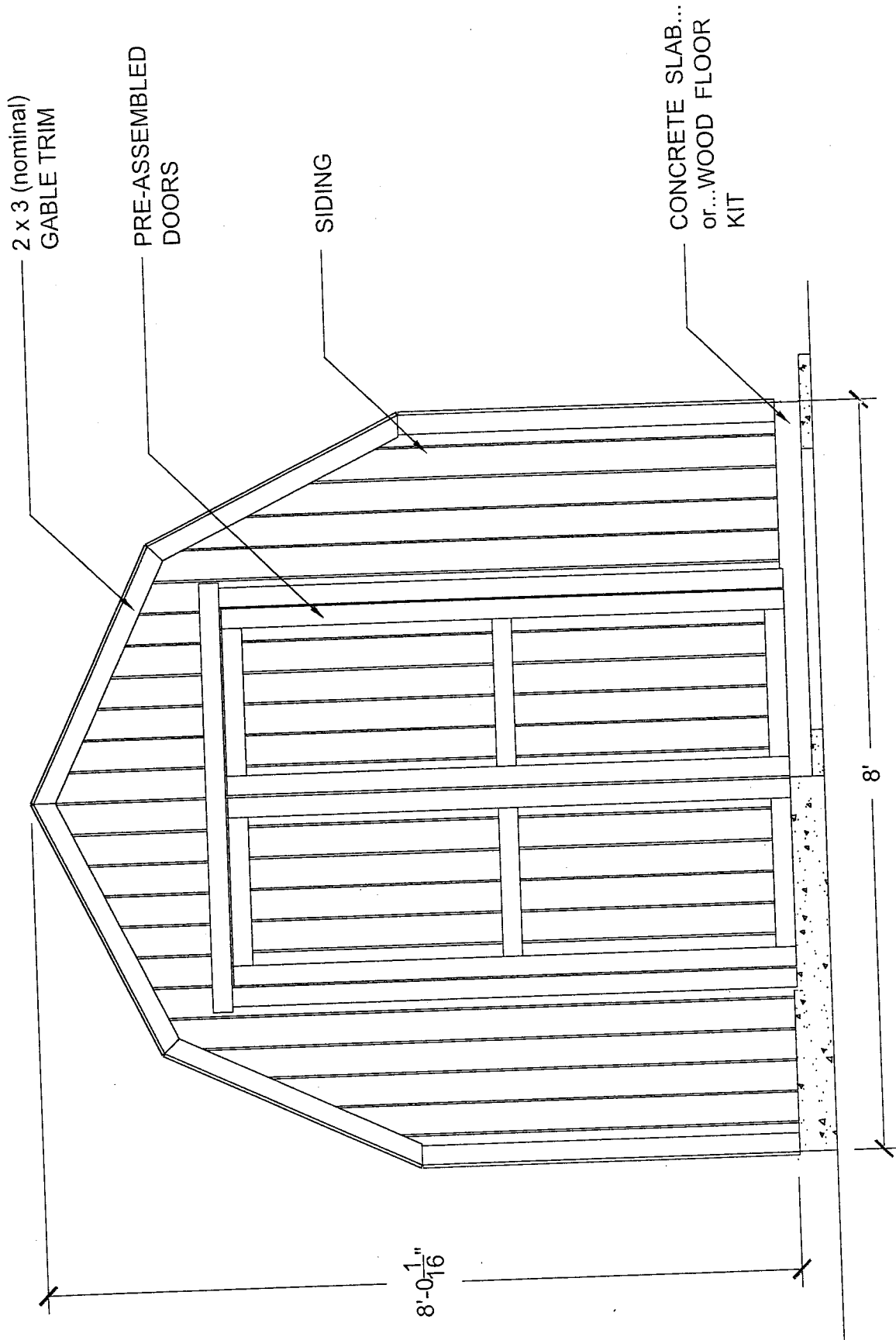

FRONT ELEVATION

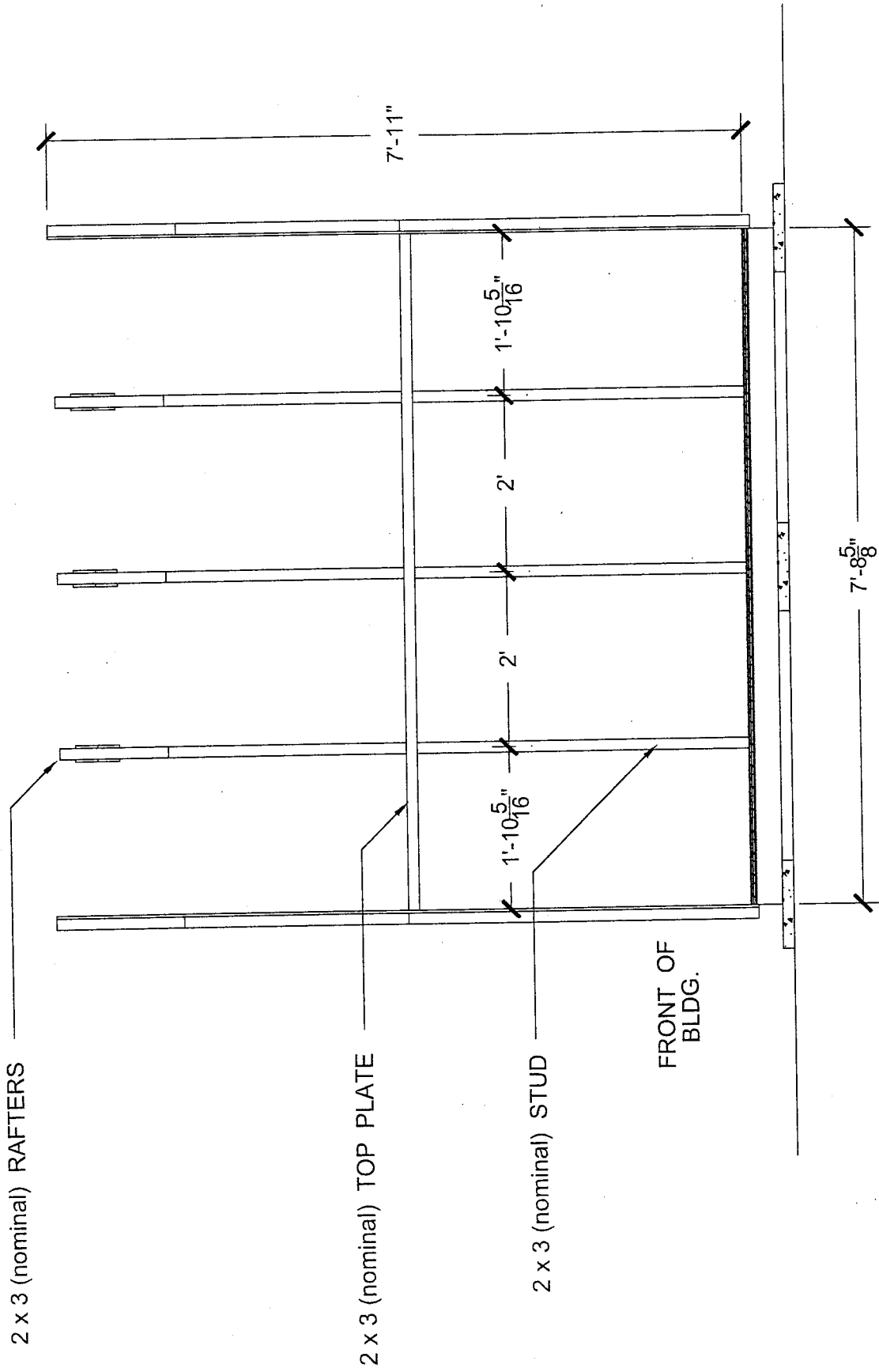

SIDE FRAMING

(2) 3/8" GUSSETS ... Fastened
With (10) 2" Nails & (2) Beads
Of Exterior Wood Glue

2 x 3 (nominal) RAFTERS
3/8" ROOF PANEL

SECURE TRUSSES with (2) 3"-16d
NAILS TOE-NAILED INTO TOP PLATE

2 x 3 (nominal) TOP PLATE

2 x 3 (nominal) STUD
SIDING

WOOD FLOOR WITH
APPROVED ANCHORS

5'-3 3/4" - 12"

ROOF PITCH

7'-2 1/2"

7'-7"

7'-11 5/16"

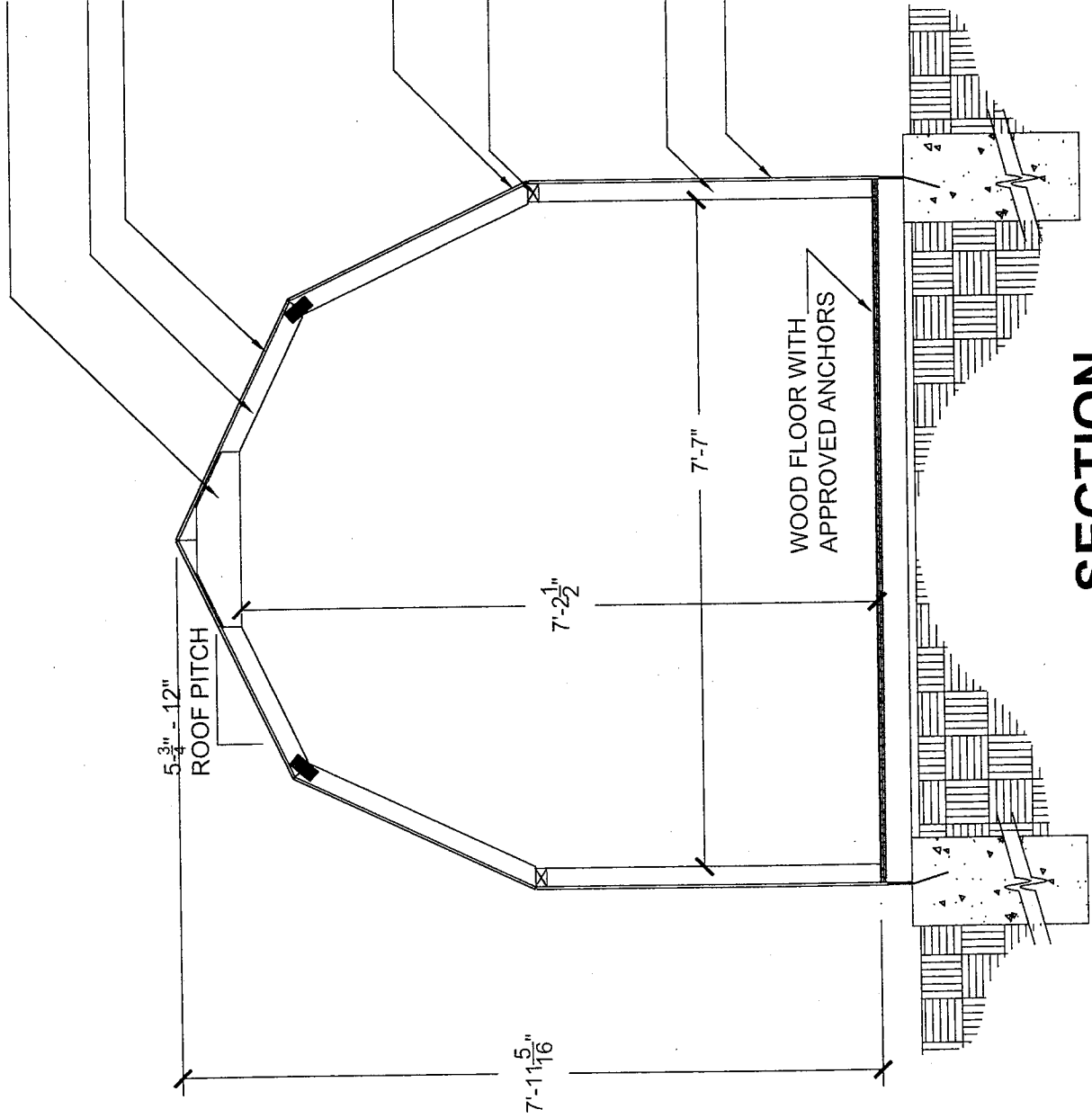

SECTION

NOTES: 1) The Roof System of this 8 ft. wide Gabrel style building has a live load capacity of 35 PSF.
 The equivalent ground snow load per ANCE 7-97 is 68 PSF which exceeds the 16.2 PSF pressure for a
 110 mph wind per ASCE 7-97.
 2) This plan supplements assembly instructions.

STRUCTURAL ANALYSIS:

f_b = 1200 PSC

f_v = 80 psi

S_x 2"x3" = 1.56 in Area = 3.75 in

DEAD LOAD:

Max Rafter Moment = f_b S_x/12=156 ft.lb.

Max Rafter Shear = 80x3.75=300 lb.

Max Stud Moment = 156 ft. lb.

WALL SYSTEM:

1) Studs 2x3@24"cc L=3.3ft. w=8M/L2=114PLF=57 PSF

2) Wind Loading V = 110 mph EXP 1

K_z=0.37 Gh=1.65 GCpl=-0.25

I=0.95 Cp=0.8

Velocity Pressure=8z=.00256K_z(IV) =10.3PSF

Design Pressure=P=qfGhCp-(qhGCpl)=16.2PSF
 ok<57PSF

ROOF SYSTEM:

1) Rafters 2x3@2'cc w=8M/L2 = 78PLF=39 PSF-4

2) Rafter Shear w=2V/L = 150 PLF=75 PSF-4

3) Sheathing w=49PSF-4=45psf

4) Ground Snow Load: Ref ASCE 7-97

P_s=35PSF I=0.8

C_s=0.95 C_e=0.8

C_t=1.2 P_f=35/0.95=36PSF

P_g=P_f/7CeC_t=68 PSF Ground Snow Capacity

8' Marco Series Gable Building

Engineering Building
Plans

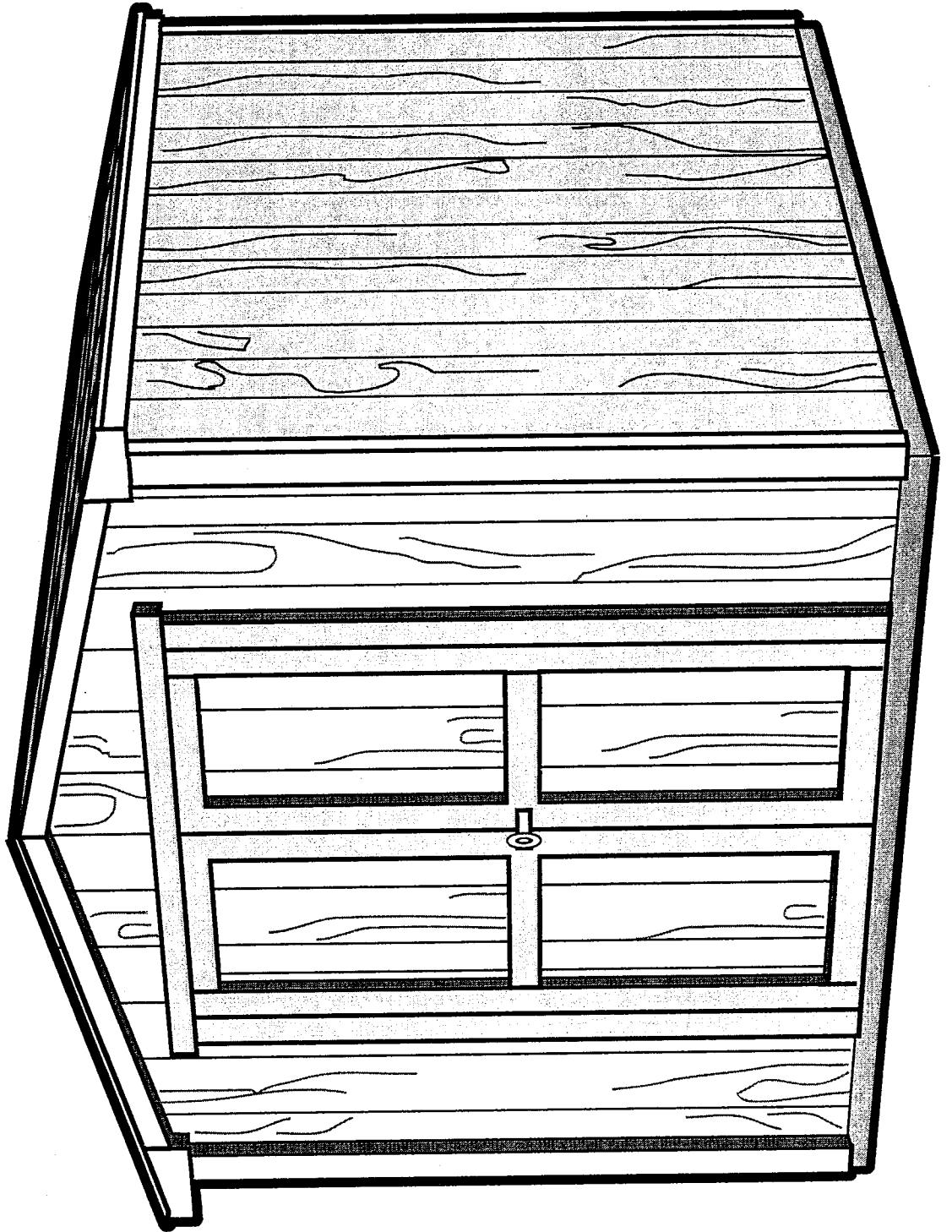

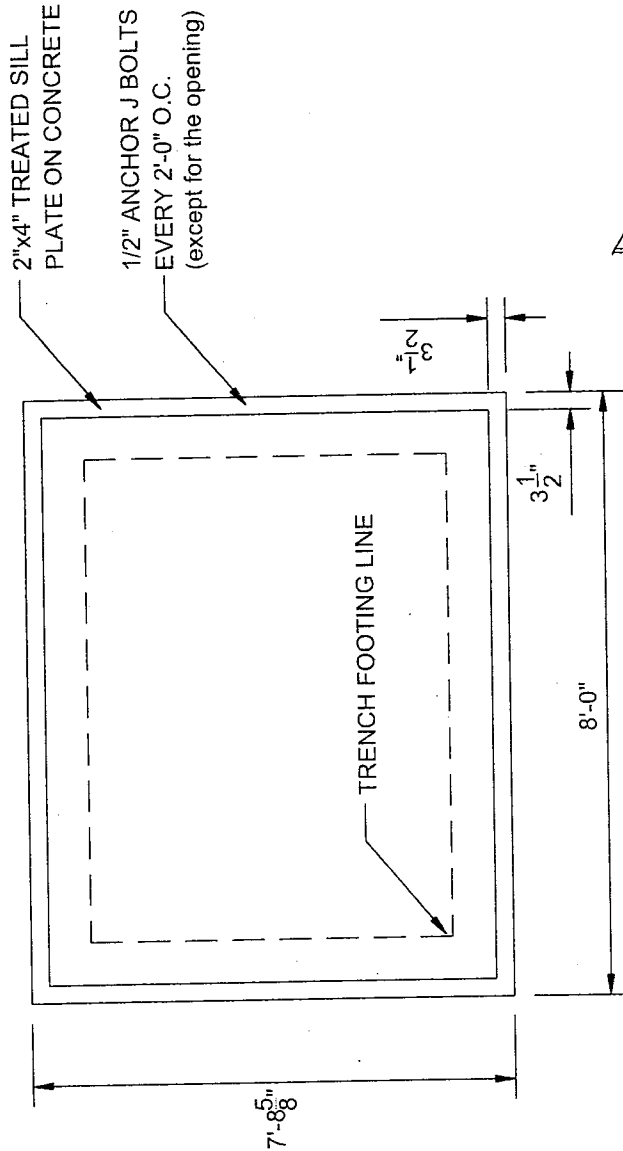

SLAB LAYOUT

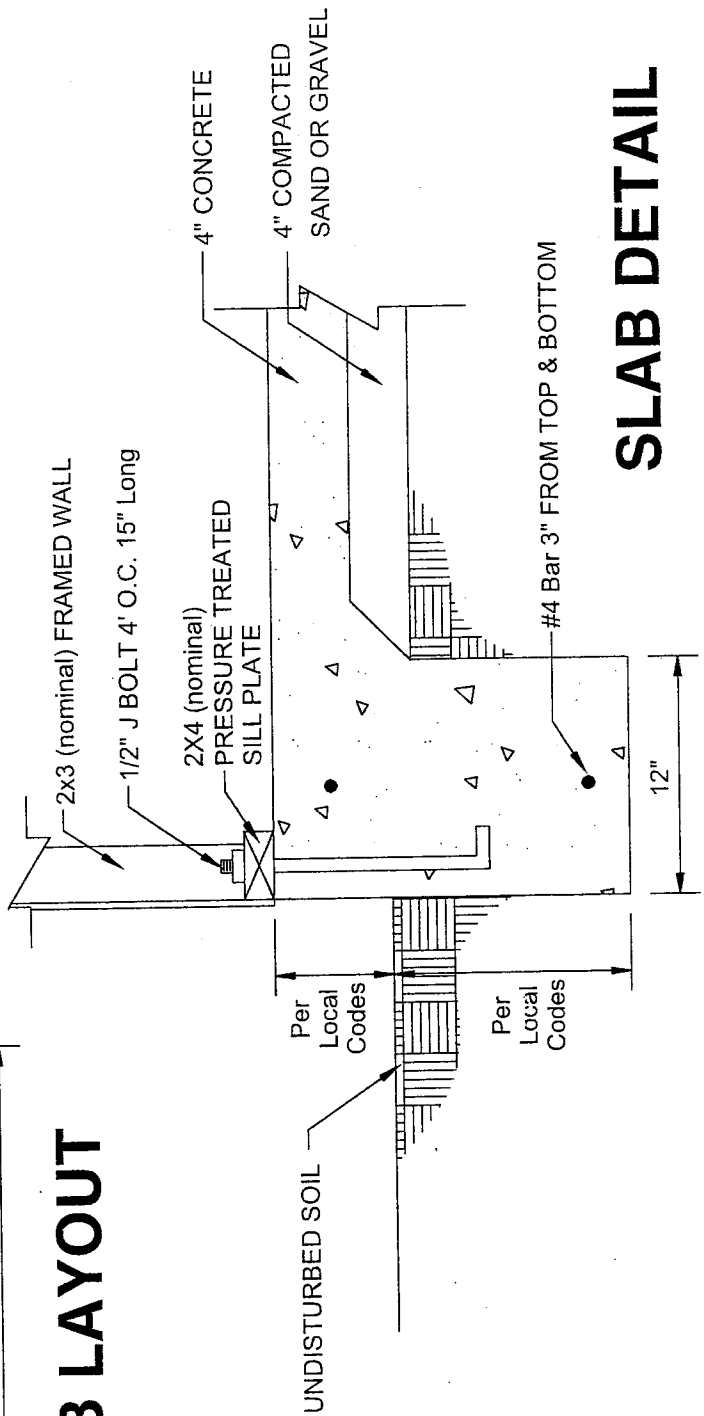

SLAB DETAIL

NOTE:

1.) ONLY THE PIERS INDICATED WITH SP ARE
REQUIRED TO HAVE SIMPSON STRONG TIES

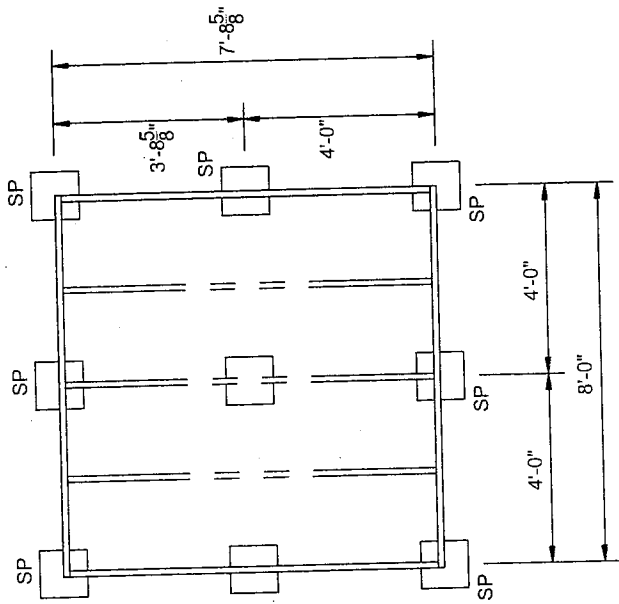

WOOD FLOOR LAYOUT

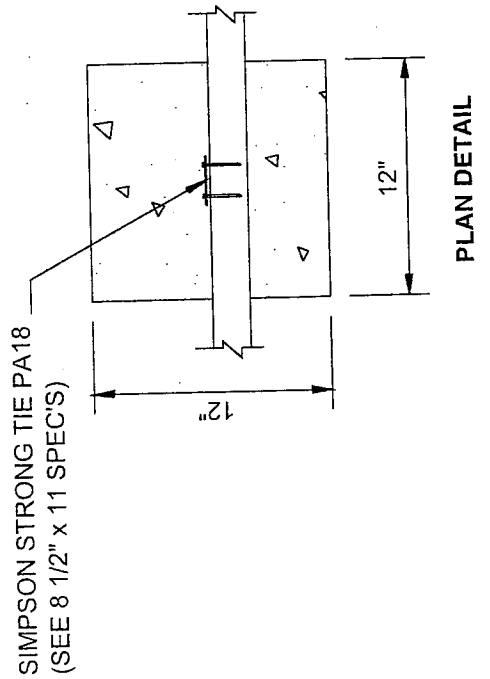
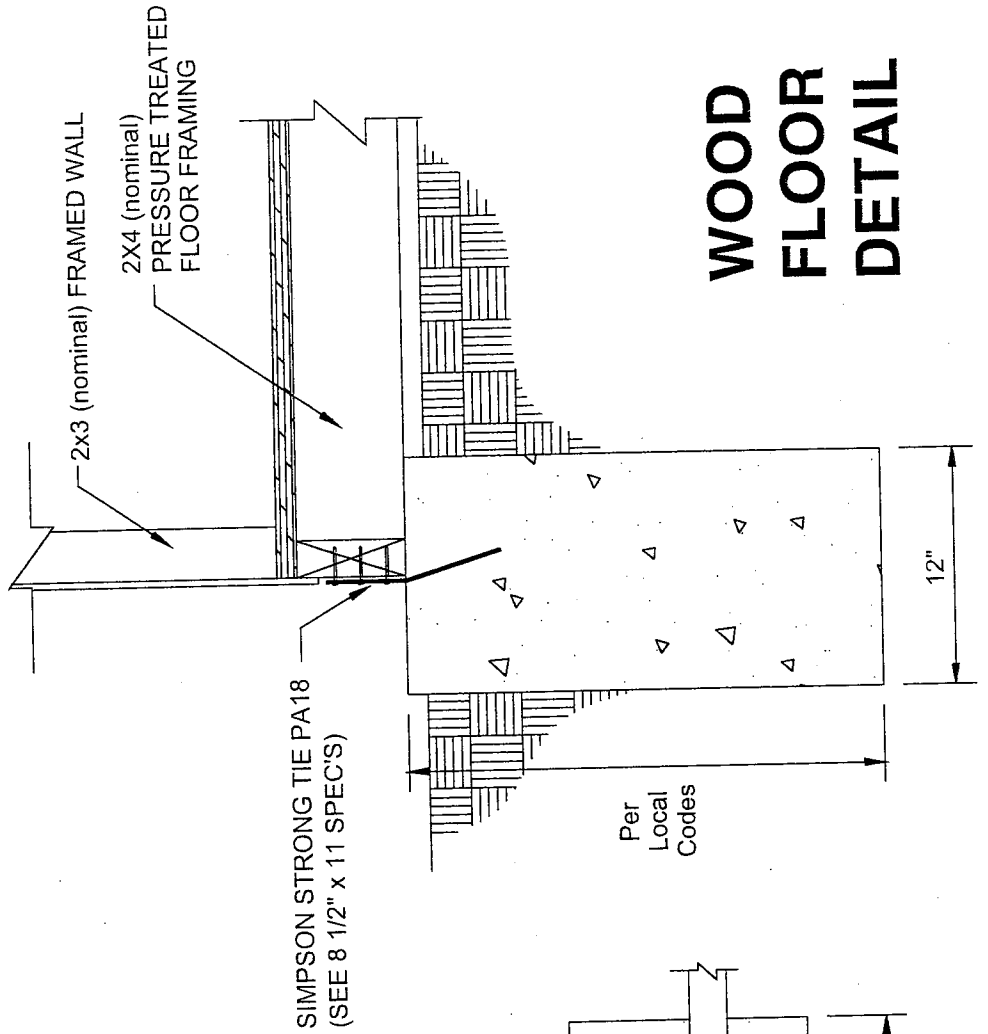

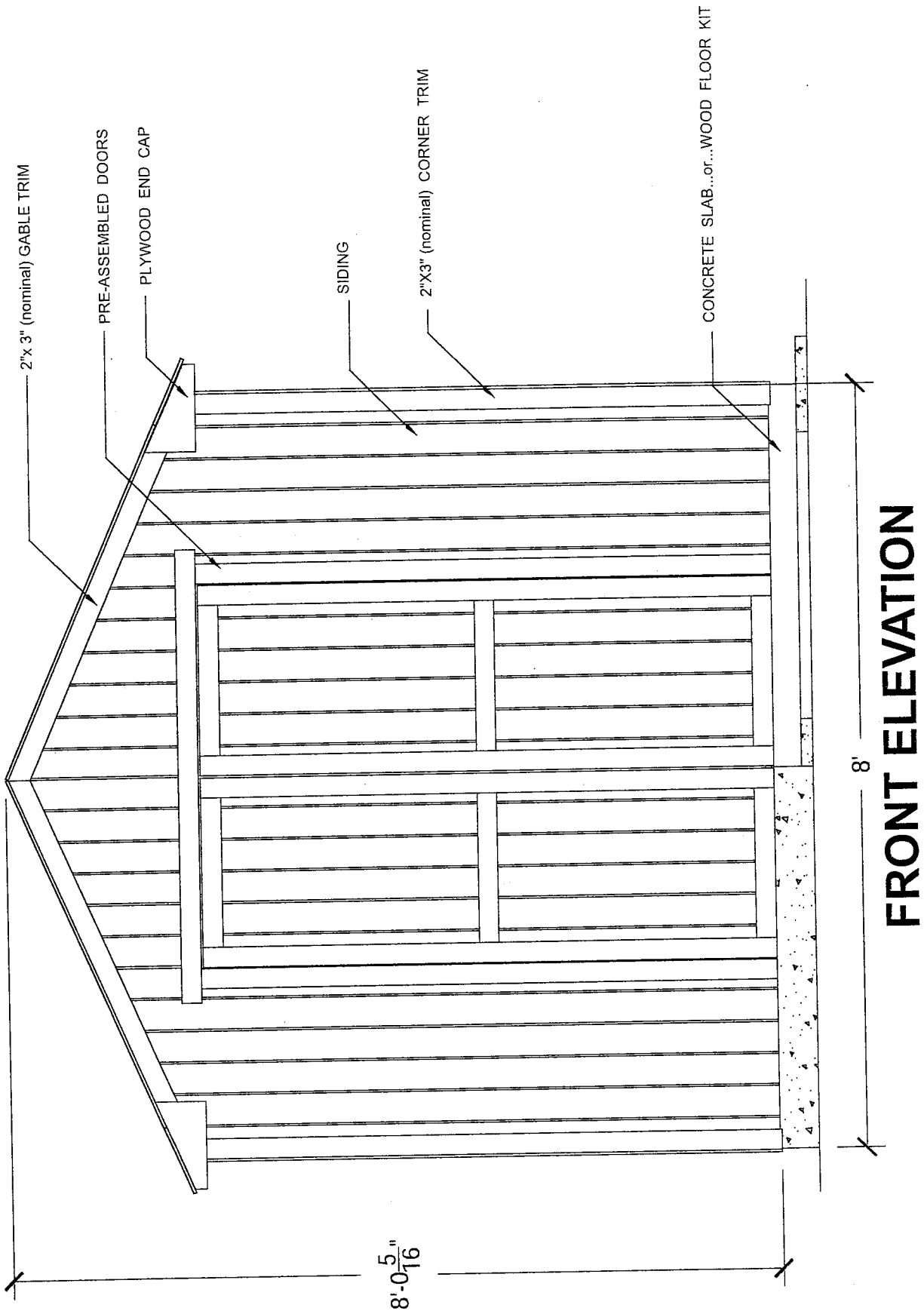

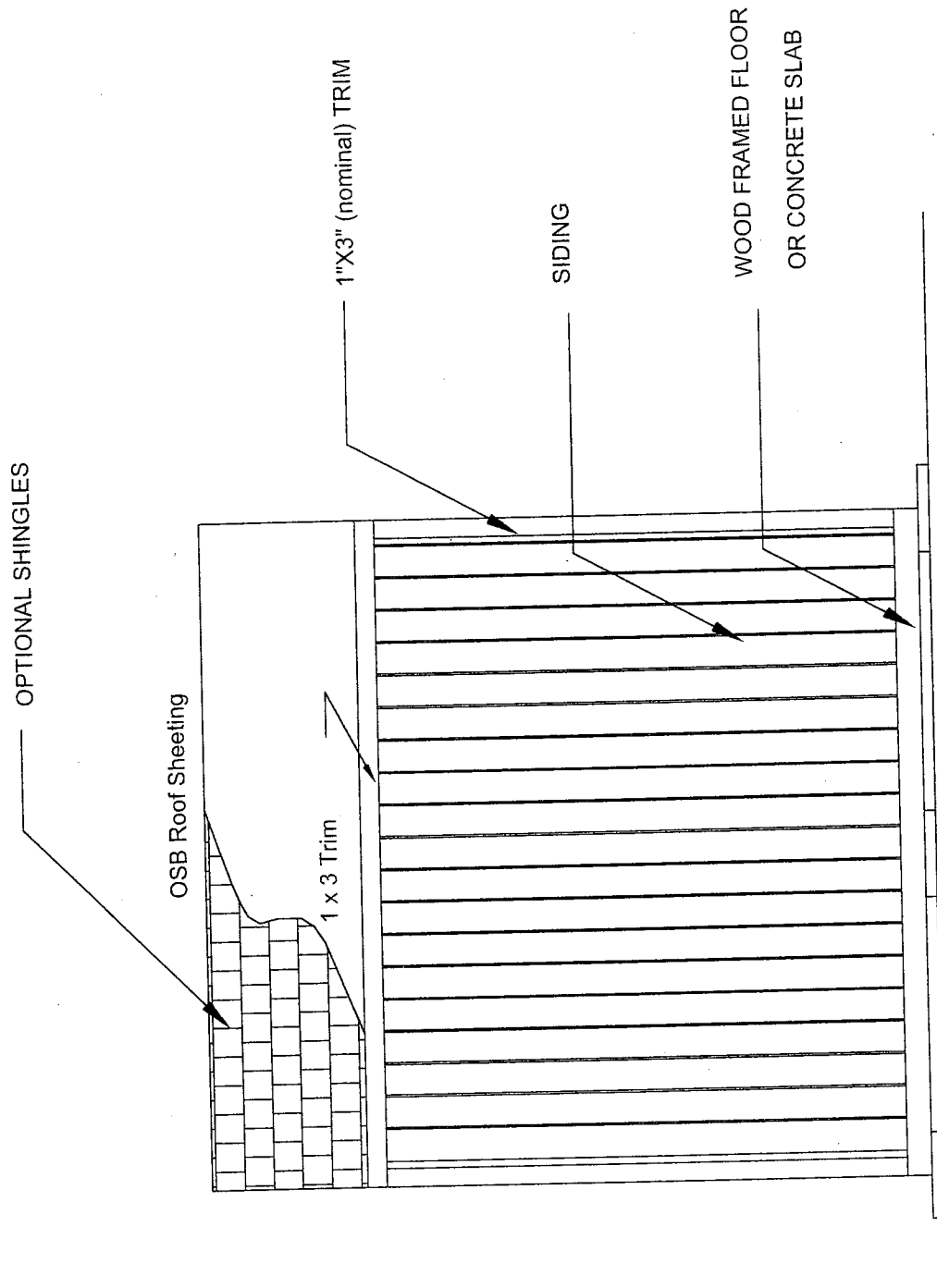

LEFT ELEVATION

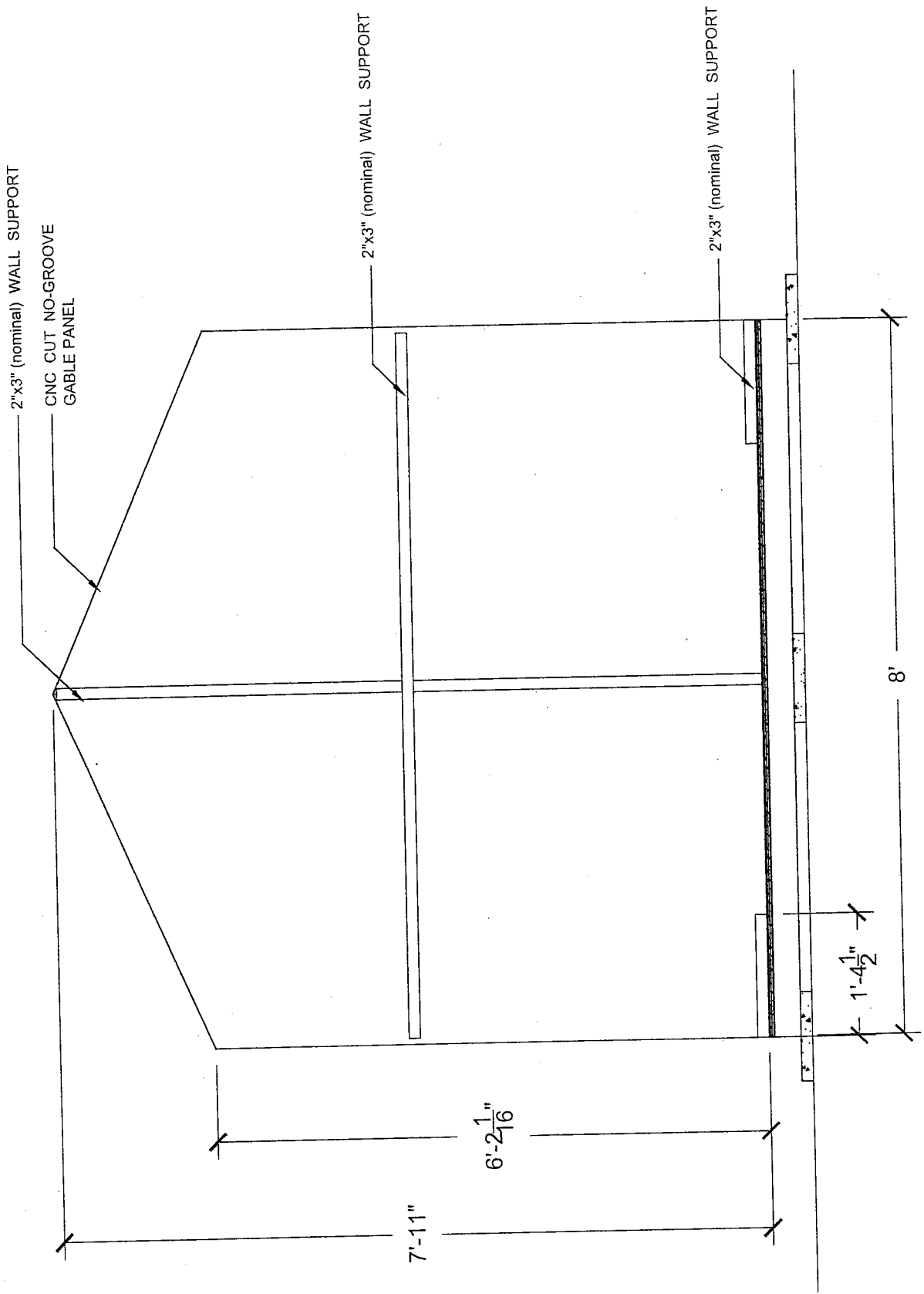

BACK WALL FRAMING

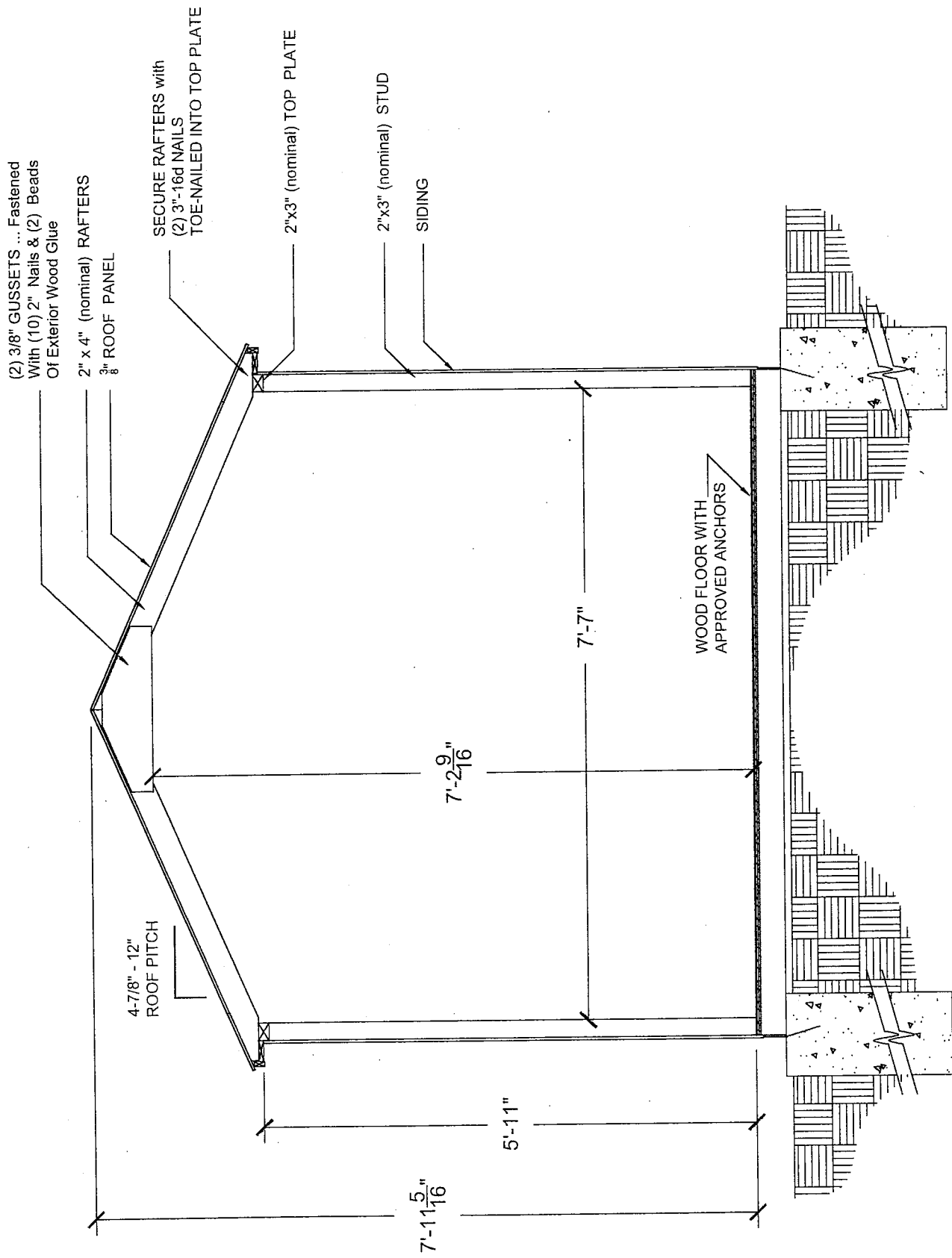

SECTION DETAIL

NOTES: 1) The Roof System of this 8 ft. wide Gable style building has a live load capacity of 45 PSF. The equivalent ground snow load per ANCE 7-98 is 88 PSF which exceeds the 17.3 PSF pressure for a 110 mph wind per ASCE 7-98.
 2) This plan supplements assembly instructions.

STRUCTURAL ANALYSIS:

fb = 1200 PSC
 fv = 80 psi
 Sx 2"x3" = 1.56 in Area = 3.75 in
 Dead Load = 4 PSF (Roof)
 Max Rafter Moment = fb Sx/12=306 ft.lb.
 Max Rafter Shear = 80x3.75=300 lb.
 Max Stud Moment = 156 ft. lb.

WALL SYSTEM:

1) Studs 2x3@24"cc L=3.3ft. w=8M/L2=114PLF=57 PSF
 2) Wind Loading V = 110 mph EXP 1
 Kz=0.37 Gh=1.65 GCpl=-0.25
 I=0.95 Cp=0.8
 Velocity Pressure=8z=.00256Kz(IV) =10.3PSF
 Design Pressure=P=qfGhCp-(qhGCpl)=16.2PSF
 ok<57PSF

ROOF SYSTEM:

1) Rafters 2x4@2'cc w=8M/L2 = 76PLF=45 PSF-4
 2) Rafter Shear w=2V/L = 117 PLF=92 PSF-4
 3) Sheathing w=45PSF-4=45psf
 4) Ground Snow Load: Ref ASCE 7-98
 Ps=45PSF I=0.8
 Cs=0.95 Ce=0.8
 Ct=1.2 Pf=45/0.95=47.4PSF
 Pg=PF/1.7CeCtI=88 PSF Ground Snow Capacity

**Exhibit "A" to Trailwoods
Design Review Guidelines**

Application for Design Review for Trailwoods

Pursuant to the Governing Documents, any Owner desiring to make any Modification to a Unit must make an application to the Design Review Board prior to commencement of work. By completing this Application and making the appropriate submittals, you successfully make your application for modifications as required by the Governing Documents. You may need additional approvals from local, state, or federal agencies. By executing and submitting this Application, the Owner(s) acknowledge that they have reviewed the Governing Documents and understand the standards applicable to Modifications and the authority and discretion afforded the DRB, all such provisions within the Governing Documents being incorporated herein by reference. If you need any additional space, please include supplement pages.

Name of Owner(s) _____

Property address: _____

Day phone _____ Evening phone _____

1. Modification Area. Approval is requested for the following Modifications as described below and on the submittal pages. The general type of Modification requested is indicated below. If applicable, appropriate submittal pages are indicated and attached to this Application. _____

2. Submittal Pages. All applications shall include appropriate submittal pages showing such design features as required by the Governing Documents and Design Review Guidelines. Failure to include the submittal pages will result in a returned Application.

Commencement date: _____ Time for completion: _____

This is a Re-application: YES NO

Owner's Signature(s) _____

[DO NOT WRITE BELOW THIS LINE]

Date Application received _____ By _____

Action on Application: Approved Denied Other _____

Date

Authorized DRB signature